

Product Information

LABO-HD1K-S

Flow Transmitter/Switch LABO-HD1K-S

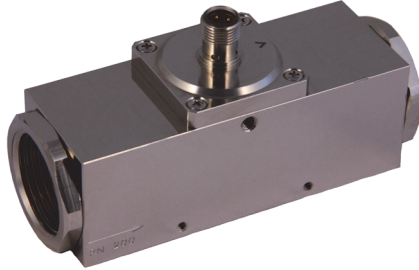

- Switching output push-pull (small hysteresis possible)
- Programmable through teaching
- LED for status display
- All metal housing
- Fully potted IP 67
- All parameters programmable via USB interface ECI-1

Characteristics

Mechanical flow switch, for fluid media, with spring-supported piston and magnetic triggering of Hall sensors. Robust construction in brass or stainless steel.

The LABO electronics fitted to the device make available an electronic switching output (Push-Pull) with adjustable characteristics (minimum/maximum) and hysteresis, which responds when an adjustable limit is fallen short of or exceeded.

If desired, the switching value can be set to the currently existing flow using "teaching". Models with analog or pulse output are also available (see separate data sheets).

In contrast to electromechanical switches (Reed contacts or micro-switches), electronic switches are insensitive to impact and wear.

There is no galvanic separation from the supply circuit.

Technical data

| | | |
|-------------------------------------|---|--|
| Sensor | analog Hall sensors | |
| Nominal width | DN 8..25 | |
| Process connection | female thread G 1/4..G 1 | |
| Metering range | 0.1..80 l/min | for details see see table "Ranges" |
| Pressure loss | 0.4..1.6 bar at Q _{max.} | |
| Q_{max.} | to 100 l/min | |
| Tolerance | ±3 % of full scale value | |
| Pressure resistance | PN 200 bar, optionally PN 500 bar | |
| Media temperature | -20..+85 °C optionally -20..+120 °C | |
| Ambient temperature | -20..+70 °C | |
| Media | water, oils (gases and aggressive media available on request) | |
| Wiring | see section "Wiring" | |
| Supply voltage | 18..30 V DC | |
| Power consumption | < 1 W | |
| Outputs | transistor output "push-pull" (resistant to short circuits, and reversal polarity protected) I _{out} = 100 mA max. | |
| Display | yellow LED (On = Normal / Off = Alarm / rapid flashing = Programming) | |
| Ingress protection | IP 67 | |
| Electrical connection | for round plug connector M12x1, 4-pole | |
| Materials medium-contact | <i>Brass construction:</i> CW614N nickelled, CW614N, 1.4310, hard ferrite, NBR | <i>Stainless steel construction:</i> 1.4571, 1.4404, 1.4310, hard ferrite PTFE-coated, FKM |
| Non-medium-contact materials | CW614N nickelled | |
| Weight | see table "Dimensions and weights" | |
| Conformity | CE | |
| Installation location | Standard: horizontal inwards flow; other installation positions are possible; the installation position affects the metering and switching range. | |

Product Information

LABO-HD1K-S

Ranges

Details in the table apply to horizontal inwards flow with increasing flow rate.

Standard type LABO-HD1K

| Metering range l/min H ₂ O | Q _{max.} recommended | Pressure loss bar at Q _{max.} H ₂ O |
|--|----------------------------------|--|
| 0.1 - 1 | 6 | 0.4 |
| 0.5 - 5 | 10 | 0.5 |
| 1.0 - 10 | 20 | 0.6 |
| 2.0 - 20 | 30 | 0.4 |
| 3.0 - 30 | 40 | |
| 4.0 - 40 | 60 | 0.8 |
| 6.0 - 60 | 80 | 1.4 |
| 20.0 - 80 | 100 | 1.6 |

Special ranges are available.

Wiring

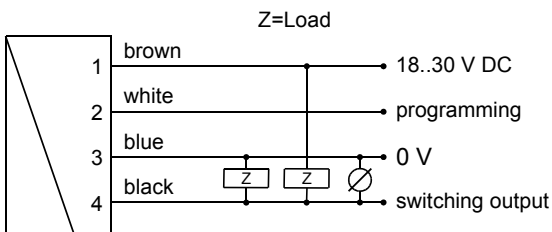

Connection example: PNP NPN

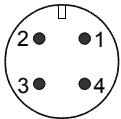

Before the electrical installation, it must be ensured that the supply voltage corresponds to the data sheet.

It is recommended to use shielded wiring.

The push-Pull output can as desired be switched as a PNP or an NPN output.

Dimensions and weights

Including LABO electronics

| | G | Types | SW | X | Weight kg |
|------------------------|-------|-----------|----|----|--------------|
| Brass | G 1/4 | ...-008GM | 40 | 15 | 1.5 |
| | G 3/8 | ...-010GM | | | |
| | G 1/2 | ...-015GM | | 18 | 1.4 |
| | G 3/4 | ...-020GM | | | |
| | G 1 | ...-025GM | | | |
| Stainless steel | G 1/4 | ...-008GK | 41 | 15 | 1.5 |
| | G 3/8 | ...-010GK | | | |
| | G 1/2 | ...-015GK | | 18 | 1.4 |
| | G 3/4 | ...-020GK | | | |
| | G 1 | ...-025GK | | | |

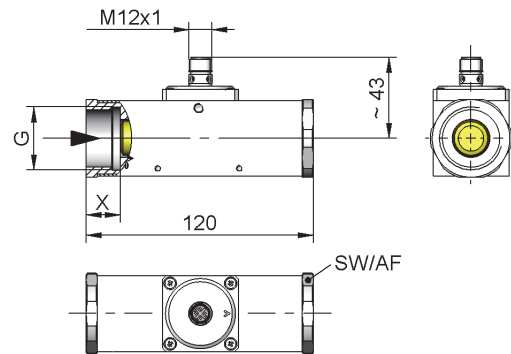

Handling and operation

Note

The switching value can be programmed by the user via "teaching". If desired, programmability can be blocked by the manufacturer.

The ECI-1 device configurator with associated software is available as a convenient option for programming all parameters by PC, and for adjustment.

- Include straight calming section of 5 x DN in inlet and outlet.
- Include a filter if the media are dirty (use magnetic filter for ferritic components)
- In case of unfavourable pressure conditions, for example at atmospheric pressure, may occur cavitation.

Product Information

Operation and programming

The switching value is set as follows:

- Apply the flow rate to be set to the device.
- Apply an impulse of at least 0.5 seconds and max. 2 seconds duration to pin 2 (e.g. via a bridge to the supply voltage or a pulse from the PLC), in order to accept the measured value.
- When the teaching is complete, pin 2 should be connected to 0 V, so as to prevent unintended programming.

The device has a yellow LED which flashes during the programming pulse. During operation, the LED serves as a status display for the switching output.

To avoid the need to transit to an undesired operating status for the purpose of teaching, the device can be provided ex-works with a teach-offset. The teach-offset value is added to the currently measured value before saving.

Example: The end of the metering range should be set to 80 %. However, only 60 % can be achieved without problem. In this case, the device would be ordered with a "teach-offset" of +20 %.. At a flow rate of 60 % in the process, teaching would then store a value of 80 %.

The LABO-HD1K-S limit switch can be used to monitor minimal or maximal.

With a minimum-switch, falling below the limit value causes a switchover to the alarm state. Return to the normal state occurs when the limit value plus the set hysteresis is once more exceeded.

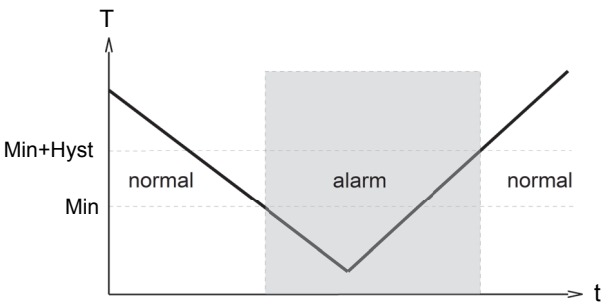

With a maximum-switch, exceeding the limit value causes a switchover to the alarm state. Return to the normal state occurs when the measured value once more falls below the limit value minus the set hysteresis.

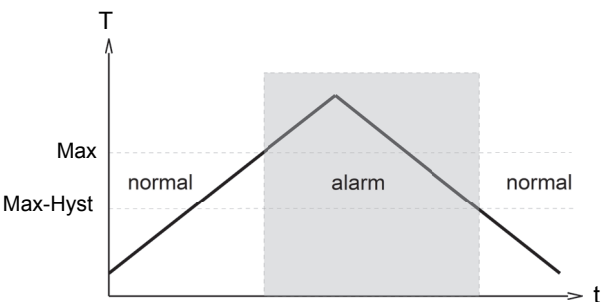

A switchover delay time (t_{DS}) can be applied to the switchover to the alarm state. Equally, one switch-back delay time (t_{DR}) of several can be applied to switching back to the normal state.

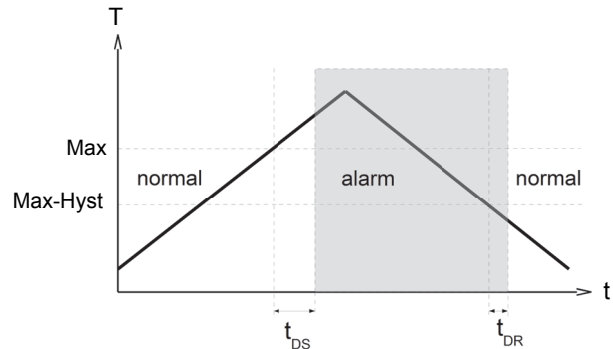

In the normal state the integrated LED is on, in the alarm state it is off, and this corresponds to its status when there is no supply voltage.

In the non-inverted (standard) model, while in the normal state the switching output is at the level of the supply voltage; in the alarm state it is at 0 V, so that a wire break would also display as an alarm state at the signal receiver. Optionally, an inverted switching output can also be provided, i.e. in the normal state the output is at 0 V, and in the alarm state it is at the level of the supply voltage.

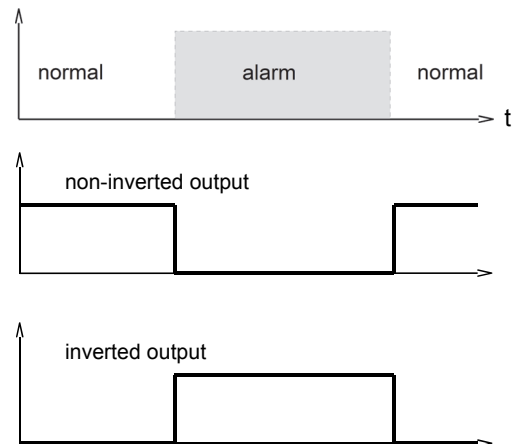

A Power-On-Delay function (ordered as a separate option) makes it possible to maintain the switching output in the normal state for a defined period after application of the supply voltage.

Product Information

LABO-HD1K-S

Ordering code

The basic device is ordered e.g. HD1K-015GM005E with electronics e.g. LABO-HD1K-SPLoS

HD1K - 1. 2. **G** 3. 4. 5. **E**

LABO-HD1K - 6. 7. 8. 9. 10. **S** 11.

| | |
|--|---|
| 1. Nominal width | |
| 008 | DN 8 - G 1/4 |
| 010 | DN 10 - G 3/8 |
| 015 | DN 15 - G 1/2 |
| 020 | DN 20 - G 3/4 |
| 025 | DN 25 - G 1 |
| 2. Process connection | |
| G | female thread |
| 3. Connection material | |
| M | brass |
| K | stainless steel |
| 4. HD1K - Metering range H₂O for horizontal inwards flow | |
| 001 | 0.1 - 1 l/min |
| 005 | 0.5 - 5 l/min |
| 010 | 1.0 - 10 l/min |
| 020 | 2.0 - 20 l/min |
| 030 | 3.0 - 30 l/min |
| 040 | 4.0 - 40 l/min |
| 060 | 6.0 - 60 l/min |
| 080 | 20.0 - 80 l/min |
| 5. Connection for | |
| E | electronics |
| 6. Switching output (Limit switch) | |
| S | Push-Pull (compatible with PNP and NPN) |
| 7. Programming | |
| P | programmable (teaching possible) |
| N | <input type="radio"/> cannot be programmed (no teaching) |
| 8. Switching function | |
| L | minimum-switch |
| H | maximum-switch |
| 9. Switching output level | |
| O | standard |
| I | <input type="radio"/> inverted |
| 10. Electrical connection | |
| S | for round plug connector M12x1, 4-pole |
| 11. Optional | |
| D | <input type="radio"/> media temperature up to 120 °C (with spacers) |

Options for LABO:

Switching delay period (0.0..99.9 s) . s
(from Normal to Alarm)

Switch-back delay period (0.0..99.9 s) . s
(from Alarm to Normal)

Power-On delay period (0..99 s) s
(After connecting the supply, time during which the switching output is not activated)

Switching output fixed at l/min

Switching hysteresis %
Standard = 2 % of the metering range

Teach-offset %
(in percent of the metering range)
Standard = 0 %

If the fields are not completed, the standard setting is selected automatically.

Options HD1K

- Special ranges

Further options available on request.

Accessories

- Cable/round plug connector (KB...) see additional information "Accessories"
- Converter OMNI-TA
- Device configurator ECI-1