

Produktinformation

Flow Transmitter / Switch FLEX-FIN



- Flow switch / transmitter for small flows
- Combination with temperature switch or transmitter possible
- No moving parts in the medium being measured
- Only one medium-contact material
- Simple to use
- Low pressure loss
- Various nominal widths
- Short response times for a calorimetric sensor
- Linearised and temperature compensated
- Simultaneous measurement of flow and temperature is possible

Characteristics

The FLEX-FIN flow sensor monitors fluid media. Its compact form combines the measurement tube and converter / counter which, depending on the model, trigger an adjustable limit value with transistor output or an analog output (4..20 mA or 0..10 V) or both. In addition, the limit switch can alternatively be replaced by a frequency output or a Pulse output.

The converter / counter record two process parameters: the flow speed of the medium and its temperature. Both parameters can be assigned to the analog output or to the switching output.

The following output combinations are available:

Flow		Temperature	
Analog	Switching output	Analog	Switching output
●			
	●		
●	●		
●			●
	●	●	

The switching output is a "push-pull" transistor output and provides PNP and NPN inputs equally. It can be offered as a minimum switch or a maximum switch, or as a frequency output or a Pulse output.

Technical data

Sensor	calorimetric measurement principle
Nominal widths	DN 6..10
Process connection	smooth tube for crimp connector or hose connection
Metering ranges (for water)	6 mm tube: (0.001) 0.01..2 l/min 8 mm tube: 0.025..5 l/min 10 mm tube: 0.05..10 l/min Special ranges available on request
Measurement accuracy	±3 % F.S. (H ₂ O dist.)
Repeatability	±1 % of the measured value (H ₂ O dist.)
Temperature gradient	4 K/s
Pressure resistance	PN 10 bar
Medium temperature	0..+70 °C (-20..+100 °C available on request)
Operating temperature	-20..+70 °C (electronics)
Storage temperature	-20..+80 °C
Pressure loss	max. 0.3 bar at max. flow
Supply voltage	24 V DC ±10 %
Current consumption	max. 100 mA
Switching output	transistor output "push-pull" (resistant to short circuits and polarity reversal) I _{out} = 100 mA max.
Switching hysteresis	flow 1 % of full scale value Temperature: approx. 1 °C
Pulse output	pulse width 50 ms → max. output frequency < 20 Hz
Display (only with switching output)	yellow LED (On = Normal / Off = Alarm / rapid flashing = Programming)
Adjustment	by means of magnet
Analog output	4..20 mA / Load 500 Ohm max. or 0..10 V / Load min. 1 kOhm
Ingress protection	IP 65
Electrical connection	for round plug connector M12x1, 4-pole
Materials medium-contact	stainless steel 1.4571 optional: hastelloy® C-276
Materials, non-medium-contact	PPS, PA6.6, CW614N
Weight	approx. 0.2 kg
Conformity	CE

Produktinformation

FLEX-FIN

Signal output curves

Value x = Begin of the specified range
 = not specified range

Current output

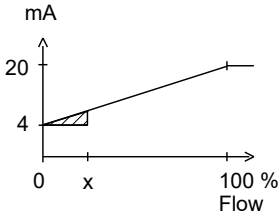

Voltage output

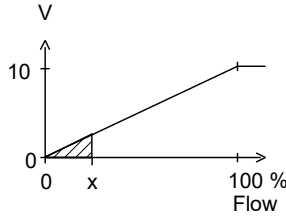

Frequency output

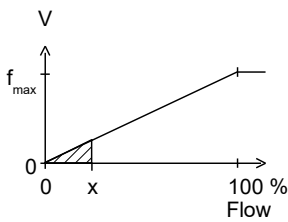

f_{max} selectable in the range of up to 2000 Hz

Other characters on request.

Wiring

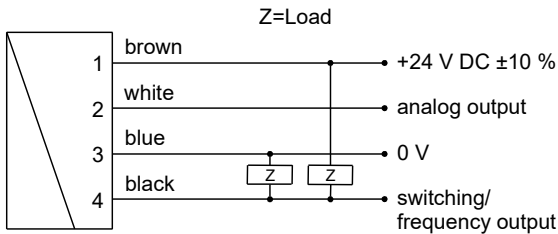

Connection example: PNP NPN

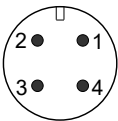

Before the electrical installation, it must be ensured that the supply voltage corresponds with the data sheet.

It is recommended to use shielded wiring.

Dimensions

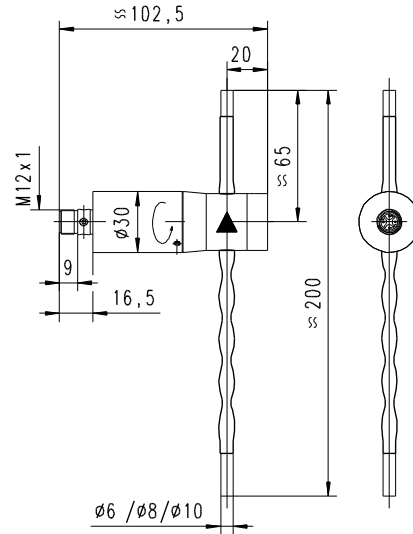

Gooseneck option

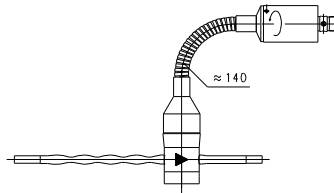

A gooseneck (optional) between the electronics head and the primary sensor provides freedom in the orientation of the sensor.

Handling and operation

Installation

In order to ensure the sensor's maximum insensitivity to interference, the flow should run from bottom to top (best degassing even at the slowest flow speed). Standard crimp connectors, hoses with crush protection, or the crimp connectors provided by HONSBERG can be used for the connection.

The insulation hoses offer the best possible insulation against the surroundings, and must therefore not be removed.

There is a marking on the rear of the housing. The sensor should be fixed there using a sheet metal screw. The penetration depth of the screw must not exceed 5 mm.

The piping must not be bent or deformed.

When testing, use only hoses, because the transmitter can no longer be returned if the connection pieces have been crimped.

Programming

The electronics contain a magnetic contact, with the aid of which different parameters can be programmed. Programming takes place when a magnet clip is applied for a period between 0.5 and 2 seconds to the marking located on the label. If the contact time is longer or shorter than this, no programming takes place (protection against external magnetic fields).



Produktinformation

FLEX-FIN

After the programming ("teaching"), the clip can either be left on the device, or removed to protect data.

The device has a yellow LED which flashes during the programming pulse. During operation, the LED serves as a status display for the switching output.

In order to avoid the need to transit to an undesired operating status during "teaching", the device can be provided ex-works with a "teach-offset". The "teach-offset" value is added to the currently measured value before saving (or is subtracted if a negative value is entered).

Example: The switching value is to be set to 70 % of the metering range, because at this flow rate a critical process status is to be notified. However, only 50% can be achieved without danger. In this case, the device would be ordered with a "teach-offset" of +20 %. At 50 % in the process, a switching value of 70 % would then be stored during "teaching".

Normally, programming is used to set the limit switch. However, if desired, other parameters such as the end value of the analog or frequency output may also be set.

The limit switch can be used to monitor minimal or maximal.

With a minimum-switch, falling below the limit value causes a switchover to the alarm state. Return to the normal state occurs when the limit value plus the set hysteresis is again exceeded.

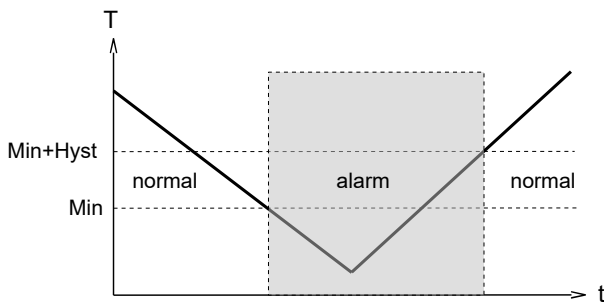

With a maximum-switch, exceeding the limit value causes a switchover to the alarm state. Return to the normal state occurs when the measured value once more falls below the limit value minus the set hysteresis.

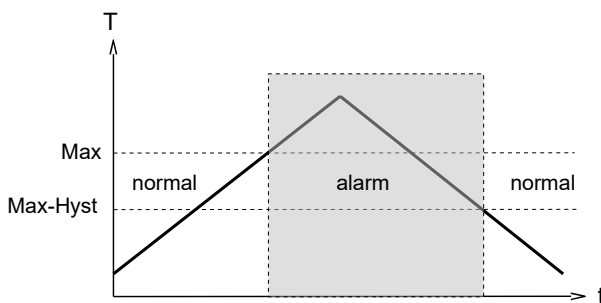

A switchover delay time (t_{DS}) can be applied to the switchover to the alarm state. Equally, one switch-back delay time (t_{DR}) of several can be applied to switching back to the normal state.

In the normal state the integrated LED is on, in the alarm state it is off, and this corresponds to its status when there is no supply voltage.

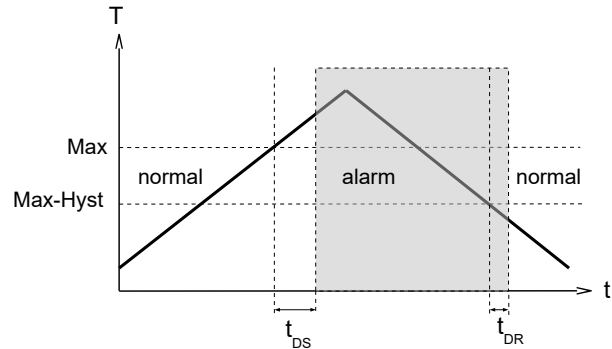

In the non-inverted (standard) model, while in the normal state the switching output is at the level of the supply voltage; in the alarm state it is at 0 V, so that a wire break would also display as an alarm state at the signal receiver. Optionally, an inverted switching output can also be provided, i.e. in the normal state the output is at 0 V, and in the alarm state it is at the level of the supply voltage.

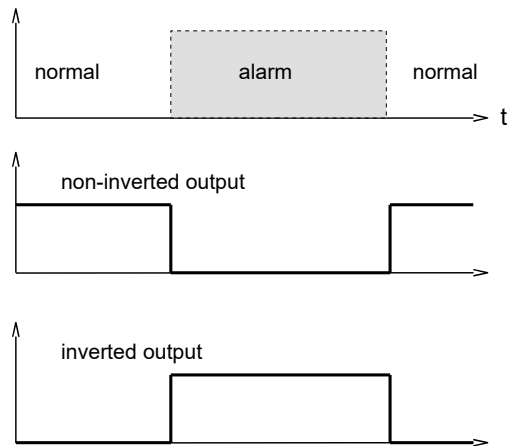

A Power-On delay function (ordered as a separate option) makes it possible to maintain the switching output in the normal state for a defined period after application of the supply voltage.

Produktinformation

FLEX-FIN

Ordering code

FLEX-FIN - 1. 2. 3. 4. 5. 6. 7. 8. 9.
 R

○=Option

1. Connection size		
006	tube Ø	6 mm
008	in mm / 0.5 mm	8 mm
010	wall thickness	10 mm
2. Process connection		
R	tube	
3. Connection material		
K	stainless steel 1.4571	
H	<input type="radio"/>	hastelloy® C-276
4. Unit for analog output		
F	flow rate to analog output	
T	temperature to analog output	
K	without Analog output	
5. Analog output		
I	current output 4..20 mA	
U	voltage output 0..10 V	
K	without Analog output	
6. Switching output		
T	switching output push-pull	
M	switching output NPN (open collector)	
K	without Switching output	
7. Measurement parameter to switching output		
F	flow to switching output	
T	temperature to switching output	
K	without switching output	
8. Function for switching output		
L	minimum switch	
H	<input type="radio"/>	maximum switch
R	frequency output	
C	Pulse output	
K	Without Switching output	
9. Switching output level		
O	standard output	
I	inverted output	

Options

Special measuring range for flow:

Metering range start value , l/min

Metering range end value

, l/min

Filter time (standard = 2 s)

s

Possible values:

OFF/0.2/0.5/1/2/4/8/16/32 s.

Special measuring range for temperature:

Maximum 100 °C (standard = 70 °C)

°C

Minimum -20 °C (standard = 0 °C)

°C

Special range for analog output:

<= Metering range (standard = metering range)

cm/s °C

Special range for frequency output:

<= Metering range (standard = Metering range)

cm/s °C

End frequency (max. 2000 Hz)

Hz

Switching delay

(from Normal to Alarm)

s

Switchback delay

(from Alarm to Normal)

s

Power-On delay (0..99 s)

(time after power on, during which the outputs are not actuated)

s

Switching output fixed

cm/s °C

Special hysteresis

(standard = 1 % of full scale value)

%

Gooseneck

If the field is not completed, the standard setting is selected automatically.

Accessories

- Crimp connector
- Connector / made-up cable
- Device configurator ECI-1
- Cable/round plug connector (KB...) see additional information "Accessories"

Required ordering information

For FLEX-FIN-C:

For the pulse output version, the volume (with numerical value and unit) which will correspond to one pulse must be stated.

Volume per pulse (numerical value)

Volume per pulse (unit)