

Product Information

ETS

Temperature Transmitter ETS



- 4..20 mA two-wire temperature transmitter
- Lance-shaped with small bulk
- Compact construction available
- Short response time
- Infinitely adjustably rotatable cable outlet for clean alignment

Characteristics

The temperature sensor consists of a PT1000 resistance sensor, which has very good dynamic behaviour. The temperature-dependent change in resistance is linearised by the downstream electronics, and converted into a temperature-proportional 4..20 mA signal. The sensor is supplied with < 4 mA, so it was possible to implement a two-wire connection. At the same time, this process connection allows monitoring for wire breaks. Because the complete upper part of the housing can be turned, it is possible to simply and infinitely adjust the cable outlet.

Technical data

Sensor	platinum resistance sensor	
Process connection	male thread G 1/4 A.. G 1/2 A, union nut G 3/4 or Tri-clamp connection	
Metering range	0..100 °C	standard range
	0..200 °C	extended range for lance shape with gooseneck
	range -20..+200 °C or partial ranges available on request	
Measurement accuracy	±1 K	
Repeatability	±0.1 K	
Dynamic (t)	3 s	
Pressure	Lance shape	PN 25
	Compact construction	PN 100
Medium	as metering range	

temperature	
Ambient temperature	-20..+70 °C
Storage temperature	-20..+80 °C
Media	water, viscous media, gases
Materials medium-contact	1.4571
Materials, non-medium-contact	FKM, CW614N nickelled, PP
Supply voltage	10..30 V DC
Analog output	4..20 mA two-wire
Load	800 Ω at 24 V (100 Ω at 10 V – 1.1 k Ω at 30 V, linear at operating voltage)
Electrical connection	for round plug connector M12x1, 4-pole or plug DIN 43650-A
Ingress protection	IP 67 (round plug connector) IP 65 (plug DIN 43650-A)
Weight	approx. 0.2 kg
Conformity	CE

Wiring

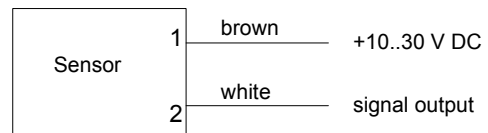

Before the electrical installation, it must be ensured that the supply voltage corresponds with the data sheet.

Dimensions

Lance shape

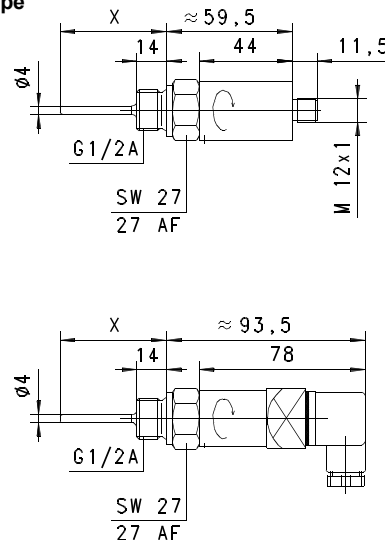

Lance type	Length X	Screw-in thread
..050..	50	G 1/2 A
..100..	100	G 1/2 A
..150..	150	G 1/2 A
..200..	200	G 1/2 A

Product Information

Compact sensor

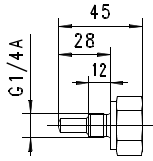

Screw-in sensor G 1/4 A
 Type ..028..

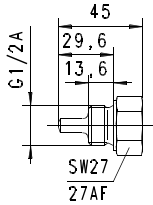

Screw-in sensor G 1/2 A
 Type ..029..

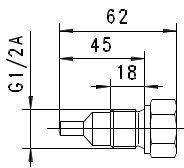

Screw-in sensor G 1/2 A
 Type ..045..

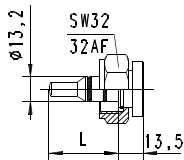

Sensor with union nut for
 T-piece G 3/8..G 1/2
 Type ..031.. (L = 31 mm)
 or
 T-piece G 3/4..G 2
 Type ..037.. (L = 37 mm)

"Gooseneck" option for higher temperatures

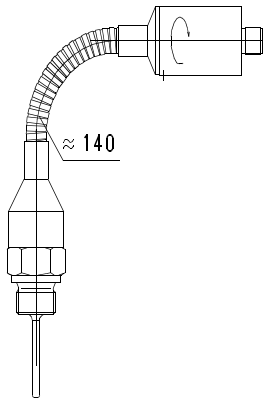

Handling and operation

Installation

Sensors with screw-in threads are screwed into a T-piece or a nozzle in the pipework, using a suitable flat seal (e.g. Klingerit). Sensors with a union nut are mounted in a T-piece (see separate product information). Use only a hexagonal spanner to tighten! It should be ensured that the sensor tip is located fully in the medium, and does not push against the wall of the pipe. The upper part of the sensor with the connector output can be turned steplessly in order to align the cable outlet.

Ordering code

ETS

ETS - 1. 2. 3. 4. 5. 6.

Option =

1. Metering range			
100	range 0..100 °C		
200	<input type="checkbox"/> range 0..200 °C		
2. Connection material			
K	stainless steel 1.4571		
3. Connection size			
008	connection G 1/4 A		
013	connection for T-piece		
015	connection for G 1/2 A		
4. Electrical connection			
S	for round plug connector M12x1		
B	DIN 43650-A plug		
5. Process connection			
050	lance length	50 mm Ø 4 mm	● ●
100		100 mm Ø 4 mm	● ●
150		150 mm Ø 4 mm	● ●
200		200 mm Ø 4 mm	● ●
028	sensor length	28 mm (G 1/4 A)	●
029		29.6 mm (G 1/2 A)	●
045		45 mm (G 1/2 A)	●
031	sensor for	T-piece G 3/8..G 1/2	●
037		T-piece G 3/4..G 2	●
6. Option			
H	<input type="checkbox"/> model with gooseneck for metering range 0..200 °C		<input type="checkbox"/> ●

Options

- Range -20..+200 °C

Accessories

- T-piece type TS-2... Thread G 3/8..G 2
- Cable/round plug connector (KB...) see additional information "Accessories"
- Evaluation electronics OMNI-TA