

Produktinformation

Switch amplifier TS125 and TS225



- 1 or 2 channel version
- Safe galvanic isolation between input / output / auxiliary voltage
- Functional safety up to SIL2 EN61508
- Inputs for switching contacts, Namur initiators, or optocouplers
- Intrinsically safe inputs for connection of sensors in Ex Zones 0 and 20
- Device installation in Ex Zone 2 possible
- Galvanic isolation in accordance with the requirements for amplified isolation (EN60664)
- Switchable monitoring of the input circuit for wire breaks and short-circuit
- Relay outputs as normally open contacts or changeovers (invertible effect)
- Wide-range mains adapter or 24 V DC
- Configuration via front DIP switches
- Plug-in coded terminal strips
- Housing width of 12.5 or 22.5mm
- Carrier rail mounting TS35 EN60715
- Operating display, switching status and error message display via LEDs

Characteristics

Switch amplifiers of the series TS125 and TW255 are used in switch cabinets for the conversion and isolation of digital switching signals, as well as in explosion-prone areas.

The devices are available in one- or two-channel versions.

Passive sensors, such as switching contacts, Namur initiators, or passive electronic outputs of third-party devices, can be connected to the intrinsically safe inputs.

The TS125 series in 12.5 mm wide carrier rail housing offers relay outputs with output make circuit. The TW225 series in 22.5 mm wide carrier rail housing offers relay outputs with changeover function. The plug-in terminal strips enable simple and time-saving wiring. The configuration is also quick and easy with the front DIP switches.

Technical data

Explosion protection

Gas:	 II (1) G [Ex ia Ga] IIC/IIB
Dust:	 II (1) D [Ex ia Da] IIIC
Intrinsically safe + Zone	 II 3 G nA nC [ic] IIB T4 Gc *)
Protection rating 'n':	 II 3 G nA nC IIB T4 Gc X *)

*) Manufacturer's certificate, requires installation in an earthed, conductive housing (minimum protection rating IP54)

Wide-range mains

Auxiliary voltage:	20..125VDC and 20..250VAC, (47..63Hz), max. 1.5W
ATEX thresholds:	$U_o = 8.7V$; $I_o = 19mA$; $P_o = 42mW$ $L_i = 20\mu H$; $C_i = 10nF$ IIB/IIIC: L_o 100 μH 1mH 100mH C_o 12.9 μF 7.3 μF 2.8 μF IIC : L_o 100 μH 1mH 100mH C_o 2.2 μF 1.2 μF 0.4 μF

24V mains adapter

Auxiliary voltage:	24V DC +/-15%, max. 1.5W
ATEX thresholds:	$U_o = 8.7V$; $I_o = 17mA$; $P_o = 37mW$ $L_i = 20\mu H$; $C_i = 10nF$ IIB/IIIB: L_o 100 μH 1mH 100mH C_o 13.9 μF 7.3 μF 2.9 μF IIC/IIIC: L_o 100 μH 1mH 100mH C_o 2.2 μF 1.3 μF 0.4 μF

Combined data

U_m (according to ATEX):	253V AC / 125V DC
Test voltage :	3kV AC between input/output/auxiliary voltage
Working temperature :	-10..60°C
Storage temperature :	-20..80°C
Air humidity :	10..90% (no condensation)

Measuring inputs (in accordance with EN60947-5-6 Namur)

Open circuit voltage :	approx. 8V
Short circuit voltage :	approx. 8mA
Switching points :	inactive $\leq 1.2mA$, active $\geq 2.1mA$, hyst. $< 0.5mA$

Error recognition

-Wire break :	$< 0.2mA$
-Short circuit :	$> 7mA$

Relay outputs

Switching voltage :	$< 250V AC < 2A < 500VA$ $< 125V DC < 0.2A < 25W$ $< 30V DC < 2A < 60W$
---------------------	---

Switching frequency :	max. 5Hz
-delay :	max. 30ms

Casing

Dimensions (WxDxH)	TS125: 12.5 x 114 x 108mm TS225: 22.5 x 114 x 108mm
--------------------	--

Material :	PA6.6, light grey, Flammability class V0 (UL94)
------------	--

Weight :	TS125: 120g; TS225: 140g
----------	--------------------------

Protection rating :	IP20
---------------------	------

Terminals :	0.2 - 2.5mm ² , AWG 24 - 14 Removable coded terminals
-------------	---

Functional safety :

SIL2 in accordance with EN61508
(specific data on request)



Produktinformation

Operation

- Green Power ON operating display

TS125....-1, TS125....-2, TS225....-1 TS225....-2

Operating elements per channel Ch.1 / Ch.2





- LEDs A1 / A2 : yellow  with active relay
 blinks  red with error status
 (wire break or short circuit)
- Switch INV : off: active input switches on the
 assigned relay
 off: active input switches off the
 assigned relay

(condition as delivered underlined)

Applications with functional safety (SIL2) require switch **INV = off** and **ERR = on** !

TS125....-F, TS225....-F

Single-channel isolating amplifier with additional error relay or parallel relay. Operating elements :

- LED A1 : yellow  with active Relay A1
 blinks  red with error status
 (wire break or short circuit)
- LED A2 : yellow  with active Relay A2
 (if switch ERR-Ch.2 = off)
 blinks  red/yellow with active
 Relay A2 with error status
 blinks  red with inactive
 Relay A2 with error status
 (if switch ERR-Ch.2 = on)
- Switch INV-Ch.1 : off: active input Ch.1
 switches on Relay A1
 on: active input Ch.1
 switches off Relay A1
- Switch ERR-Ch.1 : off: Error recognition via
 Relay A1 inactive
 on: Error recognition active
 With error status, switches
 off Relay A1
- Switch INV-Ch.2 : off: active input Ch.1 or
 alternatively an error status*)
 switch on Relay A2
 on: active input Ch.1 or
 alternatively an error status*)
 switch off Relay A2
- Switch ERR-Ch.2 off: Error recognition via relay
 A2 inactive
 (A2 switches parallel to A1)
 *) on: Error recognition active
 (see Switch INV-Ch.2)

(condition as delivered underlined)

Applications with functional safety (SIL2) require switch **INV-Ch.2 = on**, **ERR-Ch.2 = on** !

INV-Ch.1 = off, INV-Ch.2 = on, ERR-Ch.2 = off simulates a changeover contact with Relay A1 / A2

Dimensions

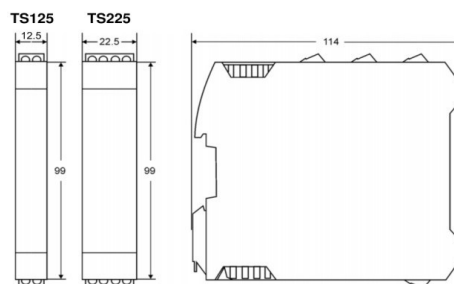

Connection diagram

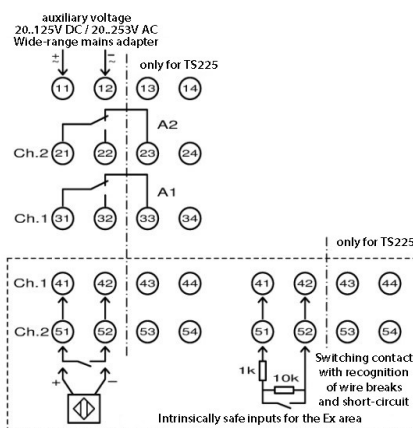

Ordering code

1. 2. 3. 4.
TS - - - -

1. Device version	
125L	Housing width 12.5mm, Relay NO contacts, Auxiliary voltage 24V DC +/-15%
125LP	Housing width 12.5mm, Relay NO contacts, Auxiliary voltage 24V DC +/-15% with DIN-rail bus connector / Power Rail *)
125M	Housing width 12.5mm, Relay NO contacts, Wide-range mains adapter 20..125 VDC, 20..250 VAC
225M	Housing width 22.5mm, Relay changeover contacts, Wide-range mains adapter 20..125 VDC, 20..250 VAC
2. Explosion protection	
00	Installation of the device TV125L in Zone 2 permitted, in accordance with ATEX ignition protection rating 'n'
Ex	With installation of the devices outside the Ex area: Inputs intrinsically safe in accordance with ATEX ignition protection rating 'ia' for Zones 0 and 20 The device TS125L may be installed in Zone 2 in accordance with ATEX ignition protection rating 'ic'.
3. Number of channels	
1	Single channel
2	Dual channel
F	Single channel with additional error relay or parallel relay
4. Options	
00	without option

*)see separate information sheet Power Rail