

Product Information

OMNI-RRI

Flow Transmitter / Switch OMNI-RRI



- Uncomplicated measurement of flow rates
- No magnets; uses inductive sensor
- Long working life thanks to high quality ceramic axis and special plastic bearing
- Run-in and run-out sections are not necessary.
- Modular construction with various connection systems
- Plug-in and rotatable connections
- Analog output 4..20 mA or 0..10 V
- Two programmable switches
- Graphical LCD display, backlit, can be read in sunlight and in the dark
- Selectable units in the display
- Programmable parameters via rotatable, removable ring (programming protection)
- Electronics housing with non-scratch, chemically resistant glass
- Rotatable electronic housing for best reading position
- Designed for industrial use
- Small, compact construction
- Simple installation
- Optionally, non-return valve, filter, constant flow rate device in the connections

Characteristics

The flow meter consists of a spinner which is rotated by the flowing medium. The rotor's rotational speed is proportional to the flow volume per unit time. The rotor is fitted with stainless steel clamps (optionally titanium or Hastelloy®). An inductive proximity switch records the rotational speed, which is proportional to the flow rate.

The OMNI transducer located on the sensor has a backlit graphics LCD display which is very easy to read, both in the dark and in bright sunlight. The graphics display allows the presentation of measured values and parameters in a clearly understandable form. The measured values are displayed to 4 places, together with their physical unit, which may also be modified by the user. The electronics have an analog output (4..20 mA or 0..10 V) and two switching outputs, which can be used as limit switches for monitoring minimal or maximal, or as two-point controllers. The switching outputs are designed as push-pull drivers, and can therefore be used both as PNP and NPN outputs. Exceeding limit values is signalled by a red LED which is visible over a long distance, and by a cleartext in the display.

The stainless steel case has a hardened non-scratch mineral glass pane. It is operated by a programming ring fitted with a magnet, so there is no need to open the operating controls housing, and its leakproofness is permanently ensured. By turning the ring to right or left, it is simple to modify the parameters (e.g. switching point, hysteresis...). To protect from

unintended programming, it can be removed, turned through 180° and replaced, or completely removed, thus acting as a key.



OPTION C:
Preset Counter with external reset option, complementary switching outputs and actual value display.

OPTION C1:
Instantaneous value display with analogue output, pulse-volume output and totalizer

Technical data

Sensor	inductive	
Nominal width	DN 10 (OMNI-RRI-010) DN 25 (OMNI-RRI-025)	
Mechanical Connection	female thread G 3/8, G 1 male thread G 3/8 A, G 1 A hose nozzle Ø11, Ø30 (other threaded, crimped, and plug-in connections, connections with constant flow rate device or limiters available on request)	
Metering ranges	0.1..100 l/min for details, see table "Ranges"	
Measurement accuracy	±3 % of the measured value	
Repeatability	±1 % of full scale value	
Pressure loss	max. 0.5 bar	
Pressure resistance	PN 16 bar	
Medium temperature	0..+60 °C	
Storage temperature	-20..+80 °C	
Materials medium-contact	Housing	PPS (Fortron 1140L4)
	Rotor	PVDF
	Clamps	1.4310 optionally: titanium or Hastelloy®
	Bearing	Igldur X
	Axis	Ceramic ZrO ₂ -TZP
	Seal	FKM
Materials, non-medium-contact	Clamps	1.4301
	Electronic adapter	CW614N nickelled
	Electronics housing	Stainless steel 1.4305
	Glass	Mineral glass, hardened
	Magnet	Samarium-Cobalt
	Ring	POM
Supply voltage	18..30 V DC	
Power consumption	< 1 W	
Analog output	4..20 mA / max. load 500 Ω or 0..10 V / min. load 1 kΩ	

Product Information

Switching output	transistor output "push-pull" (resistant to short circuits and polarity reversal) $I_{out} = 100 \text{ mA max.}$	
Hysteresis	adjustable, position of the hysteresis depends on minimum or maximum	
Display	backlit graphical LCD-Display (transreflective), extended temperature range $-20..+70 \text{ }^\circ\text{C}$, 32×16 pixels, background illumination, displays value and unit, flashing LED signal lamp with simultaneous message on the display.	
Electrical connection	for round plug connector M12x1, 5-pole	
Ingress protection	IP 67 / (IP 68 when oil-filled)	
Weight	OMNI-RRI-010	approx. 0.4 kg
	OMNI-RRI-025	approx. 0.7 kg
Conformity	CE	

Signal output curves

Value x = Begin of the specified range
 = not specified range

Current output

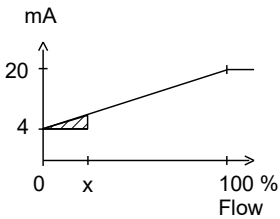

Voltage output

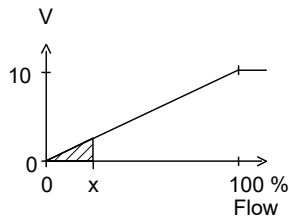

Other characters on request.

Ranges

Metering range l/min (H ₂ O)	Types	Q _{max} l/min (H ₂ O)
0.1.. 1.5	OMNI-RRI-010...020	1.8
0.2.. 10.0	OMNI-RRI-010...050	12.0
0.4.. 12.0	OMNI-RRI-010...070	14.4
2.0.. 30.0	OMNI-RRI-025...080	36.0
3.0.. 60.0	OMNI-RRI-025...120	72.0
4.0.. 100.0	OMNI-RRI-025...160	120.0

The measured values were determined with horizontal flow (OMNI electronics upwards) using water at 25 °C.

Wiring

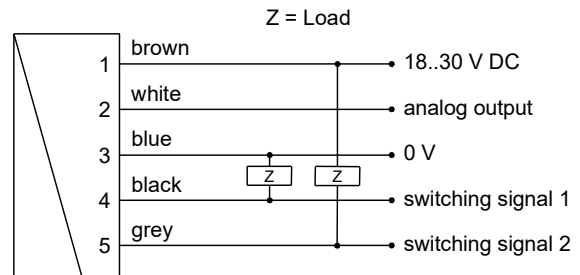

Connection example: PNP NPN

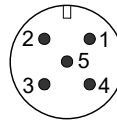

connector M12x1

See separate wiring at C and C1 option in the separate descriptions.

Before the electrical installation, it must be ensured that the supply voltage corresponds to the data sheet. The use of shielded cabling is recommended.

Dimensions

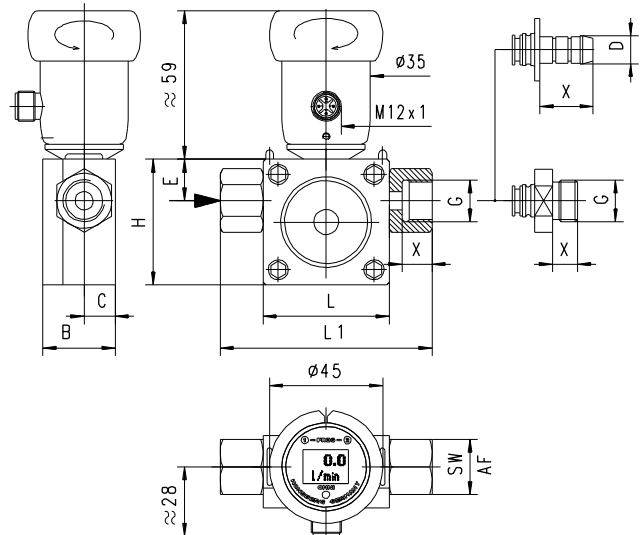

Threaded connection

G	DN	Types	H/L	L1	B	C	E	X	SW
G 3/8	10	RRI-010G	50	84	29	12.5	16.5	12	22
G 3/8 A		RRI-010A						14	
G 1	25	RRI-025G	70	110	53	23.0	27.5	18	38
G 1 A		RRI-025A		122					

NPT threads on request

Product Information

OMNI-RR1

Hose nozzle connection

D	DN	Types	H/L	L1	B	C	E	X
Ø11	10	RRI-010T	50	96	29	12.5	16.5	21
Ø30	25	RRI-025T	70	176	53	23.0	27.5	45

Custom specific connectors on request

Gooseneck option



A gooseneck (optional) between the electronics head and the primary sensor provides freedom in the orientation of the sensor. This option simultaneously provides thermal decoupling between the two units

Handling and operation

Installation

The Rototron device is installed in the pipework with the aid of the rotatable adapter pieces. If necessary, the adapters can be removed from the body of the housing after the stainless steel clips have been removed from the housing. Before reinstalling, it should be ensured that both the adapter with the O-ring and the sealing surface in the body are clean and undamaged. The adapters should be fitted carefully in the housing (it is best to turn them), so that the O-ring is not damaged.

With this flow sensor, there is no need for run-in and run-out sections. However, it should be ensured that the flow sensor is at all times filled with medium. Any preferred installation position is possible, but the best possible venting position should be chosen (rotor axis horizontal, flow horizontal or from bottom to top).

Air bubbles affect the measurement results. For filling processes, the valve should be installed behind the sensor. A running up time of approx. 0.5 seconds and a running down time of approx. 3 seconds should be noted.

Programming

The annular gap of the programming ring can be turned to positions 1 and 2. The following actions are possible:



Set to 1 = continue (STEP)
Set to 2 = modify (PROG)

Neutral position between 1 and 2

The ring can be removed to act as a key, or turned through 180° and replaced to create a programming protector.

Operation is by dialog with the display messages, which makes its use very simple.

Starting from the normal display (present value and unit), if 1 (STEP) is repeatedly selected, then the display shows the following information in this order:

Display of the parameters, using position 1

- Switching value S1 (switching point 1 in the selected unit)
- Switching characteristic of S1
MIN = Monitoring of minimum value
MAX = Monitoring of maximum value
- Hysteresis 1 (hysteresis value of S1 in the set

unit)

- Switching value S2
- Switching characteristic of S2
- Hysteresis 2
- Code
After entering the **code 111**, further parameters can be defined:
- Filter (settling time of the display and output)
- Physical unit (Units)
- Output: 0..20 mA or 4..20 mA
- 0/4 mA (measured value corresponding to 0/4 mA)
- 20 mA (measured value corresponding to 20 mA)

For models with a voltage output, replace 20 mA accordingly with 10 V.

Edit, using position 2

If the currently visible parameter is to be modified:

- Turn the annular gap to position 2, so that a flashing cursor appears which displays the position which can be modified.
- By repeatedly turning to position 2, values are increased; by turning to position 1, the cursor moves to the next digit.
- Leave the parameter by turning to position 1 (until the cursor leaves the row); this accepts the modification.
- If there is no action within 30 seconds, the device returns to the normal display range without accepting the modification.

The limit switches S1 and S2 can be used to monitor minimal or maximal.

With a minimum-switch, falling below the limit value causes a switchover to the alarm state. Return to the normal state occurs when the limit value plus the set hysteresis is once more exceeded.

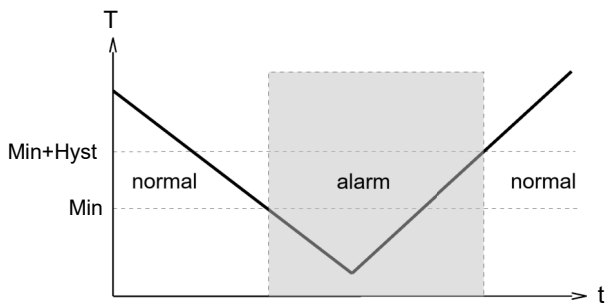

With a maximum-switch, exceeding the limit value causes a switchover to the alarm state. Return to the normal state occurs when the measured value once more falls below the limit value minus the set hysteresis.

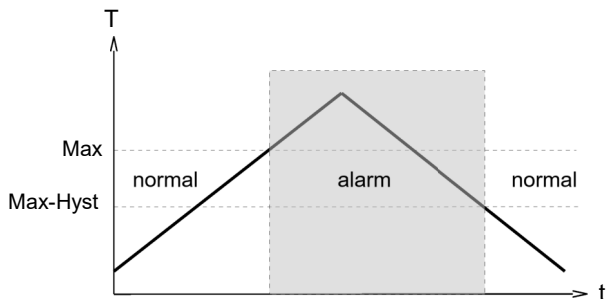

The change to the alarm state is indicated by the integrated red LED and a cleartext in the display.

While in the normal state the switching outputs are at the level of the supply voltage; in the alarm state they are at 0 V, so that a wire break would also display as an alarm state at the signal receiver.

Overload display

Product Information

OMNI-RRI

Overload of a switching output is detected and indicated on the display ("Check S 1 / S 2"), and the switching output is switched off.

Simulation mode

To simplify commissioning, the sensor provides a simulation mode for the analog output. It is possible to create a programmable value in the range 0..26.0 mA at the output (without modifying the process variable). This allows the wiring run between the sensor and the downstream electronics to be tested during commissioning. This mode is accessed by means of **Code 311**.

Factory settings

After modifying the configuration parameters, it is possible to reset them to the factory settings at any time using **Code 989**

Ordering code

The basic device is ordered e.g. RRI-010...
with electronics e.g. OMNI-RRI-010...

RRI- 1. 2. 3. 4. 5. 6. 7. 8. 9. **E**

OMNI-RRI- 10. 11. **S** 12. 13. 14.

○=Option

1. Nominal width		
010	DN 10	
025	DN 25	
2. Mechanical connection		
G	female thread	
A	male thread	
T	hose nozzle	
3. Connection material		
V	PVDF	
M	<input type="radio"/> CW614N nickelled	
K	<input type="radio"/> 1.4305	
4. Housing material		
Q	PPS	
V	PVDF	
A	<input type="radio"/> PPS with transparent cover PSU	
5. Inwards flow drilling		
020	Ø 2.0	●
050	Ø 5.0	●
070	Ø 7.0	●
080	Ø 8.0	●
120	Ø12.0	●
160	Ø16.0	●
6. Seal material		
V	FKM	
E	<input type="radio"/> EPDM	
N	<input type="radio"/> NBR	
7. Rotor		
10	with 10 clamps	
02	<input type="radio"/> with 2 clamps	
05	<input type="radio"/> with 5 clamps	
8. Material for clamps		
K	1.4310	
T	<input type="radio"/> titanium	
H	<input type="radio"/> Hastelloy®	
9. Connection for		
E	electronics	
10. For nominal width		

010	DN 10	
025	DN 25	
11. Analog output		
I	current output 0/4..20 mA	●
U	<input type="radio"/> voltage output 0/2..10 V	●
K	ohne	●
12. Electrical connection		
S	for round plug connector M12x1, 5-pole	
13. Option		
H	gooseneck	
O	<input type="radio"/> tropical model - oil-filled version for heavy duty or external use	
14. Option 2		
C	<input type="radio"/> Counter C	
C1	<input type="radio"/> Counter C1	

Options

- Counter C (hardware and software option):
Preset Counter with external reset option, complementary switching outputs and actual value display (modified wiring diagram!)

Counter C1 (software option):
Instantaneous value display with analogue output, pulse-volume output and totalizer

- Rotor with titanium clamps

Accessories

- Cable/round plug connector (KB...)
see additional information "Accessories"
- Device configurator ECI-1
- Mechanical connection pieces with non-return valve, filter, constant flow device or customer-specific requirements available on request