

**Product Information**

**OMNI-F**

# Flow Transmitter / Switch OMNI-F



- Flow indicator for industrial use, without moving parts
- Short response times for a calorimetric sensor
- Medium comes into contact with only one material
- Analog output 4..20 mA or 0..10 V
- Two programmable switches (push-pull)
- Graphical LCD display, backlit (transreflective), can be read in sunlight and in the dark
- Programmable parameters via rotatable, removable ring (programming protection)
- Full metal housing with non-scratch, chemically resistant glass
- Rotatable electronic head for best reading position
- Small, compact construction
- Simple installation

## Characteristics

The calorimetric sensor measures the flow speed in aqueous fluids. The display shows the measured value in a range from 0..100 % as a digital value and as a bar graph. The measured value is output as a 0/4..20 mA value. Both the 0/4 mA and the 20 mA value can be programmed via a scaling of the display range, and so the sensor can be adapted to any flow speed lying within the overall range. Measurement is supported in terms of temperature compensation and signal processing (linearisation, interpolation, amplification) by the use of a microcontroller. Because a conclusion on the whole cross-section is drawn based on a point measurement in a pipe, the accuracy achievable is not so good as with a flow sensor in a permanently installed tube (OMNI-FIN or FLEX-FIN).

By turning the programming ring to right or left, it is simple to modify the parameters (e.g. switching point, hysteresis...). To protect from unintended programming, it can be removed, turned through 180 °, and replaced, or completely removed, thus acting as a key.



## Technical data

<b>Sensor</b>	calorimetric measurement principle	
<b>Process connection</b>	screw-in thread G 1/4 A..G 1/2 A, push-in sensor Ø12 mm	
<b>Metering range</b>	water 2..150 cm/s range, 3..300 cm/s available on request oil (available on request)	
<b>Measurement accuracy</b>	dependent on the installation location and flow conditions typically ±10 % of full scale value or 2 cm/s, of full scale value measured in the T-piece ±5 %	
<b>Repeatability</b>	±1 %	
<b>Dynamics</b>	in water (25 °C) at average flow speed of approx. 1-2 s	
<b>Hysteresis</b>	adjustable, position of hysteresis depends on min. or max. switching value	
<b>Pressure resistance</b>	PN 100 bar (PN 200 bar available on request)	
<b>Medium temperature</b>	0..+70 °C	
<b>Ambient temperature</b>	-20..+70 °C	
<b>Storage temperature</b>	-20..+80 °C	
<b>Materials medium-contact</b>	stainless steel 1.4571	
<b>Materials non-medium-contact</b>	Housing	Stainless steel 1.4305
	Glass	Mineral glass, hardened
	Magnet	Samarium-Cobalt
	Ring	POM
<b>Supply voltage</b>	24 V DC ±10 %	
<b>Analog output</b>	0/4..20 mA or 0/2..10 V	
<b>Power consumption</b>	< 1 W	
<b>Switching outputs S1 and S2</b>	transistor output "push-pull" (resistant to short circuits and polarity reversal) I <sub>out</sub> = 100 mA max. per output	
<b>Display</b>	backlit graphical LCD-Display (transreflective), extended temperature range -20..+70 °C, 32 x 16 pixels, background illumination, displays value and unit, flashing LED signal lamp with simultaneous message on the display.	
<b>Electrical connection</b>	for round plug connector M12x1, 5-pole	
<b>Ingress protection</b>	IP 67	
<b>Weight</b>	approx. 0.25 kg	
<b>Conformity</b>	CE	

**Product Information**

**Signal output curves**

Value x = Begin of the specified range  
 = not specified range

Current output

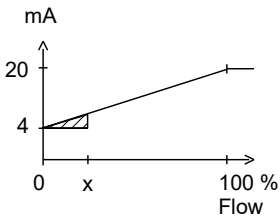

Voltage output

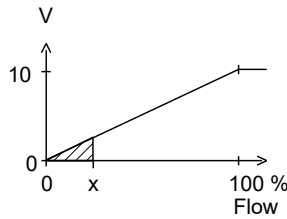

Other characters on request.

**Wiring**

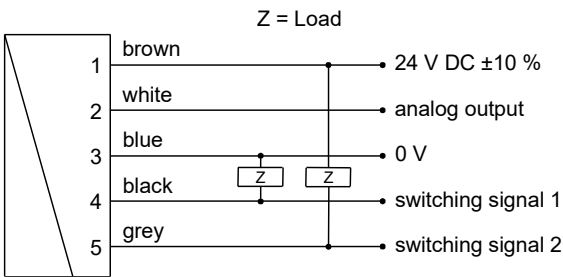

Connection example: PNP NPN

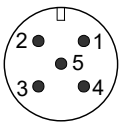

connector M12x1

Before the electrical installation, it must be ensured that the supply voltage corresponds to the data sheet.  
 The use of shielded cabling is recommended.

**Dimensions**

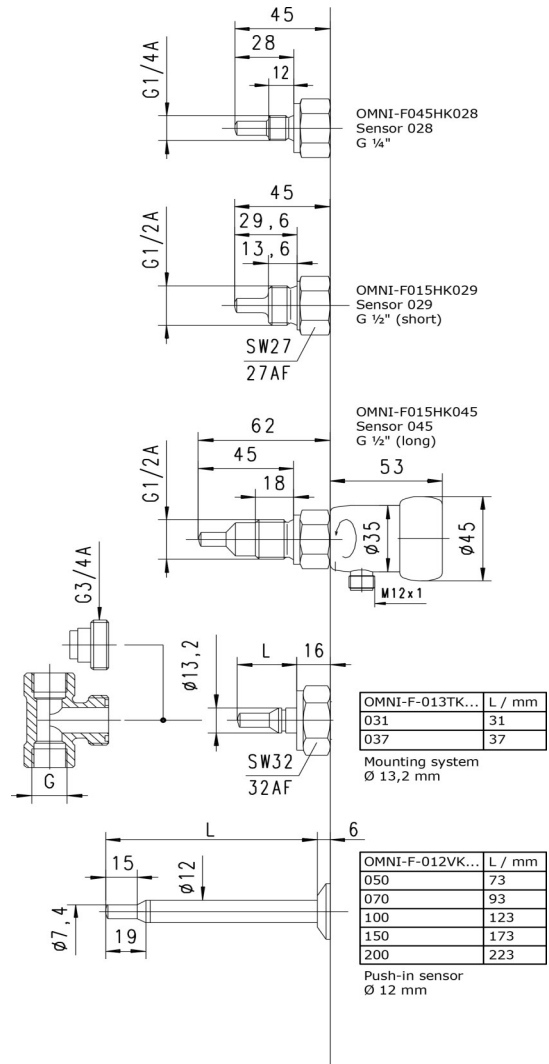

**Gooseneck option**



A gooseneck (optional) between the electronics head and the primary sensor provides complete freedom in the orientation and reading direction of the sensor.

**Handling and operation**

**Installation**

In order to ensure the sensor's maximum insensitivity to interference, the flow should run from bottom to top (best degassing even at the slowest flow speed).

Screw-in sensors are to be sealed using Teflon tape, so that the inwards flow is directed to the incised cross. This is the position at which measurement is undertaken in the factory, and which guarantees the best results. The sensor must be screwed in using its hexagonal spanner only.

**Product Information**

A gooseneck (optional) between the electronics head and the primary sensor provides freedom in the alignment and reading direction of the sensor. This option simultaneously provides thermal decoupling between the two units

There are various options for installing the 12 mm push-in sensors (OMNI-F012):

The stainless steel compression fittings are screwed into a G<sup>1</sup>/<sub>2</sub> threaded drilling. For this, a G<sup>1</sup>/<sub>2</sub> welded-on nozzle is also available. When a suitable seal is used, this arrangement can take pressures up to 40 bar. The stainless steel threaded connection is first tightened by hand, and then by 1/4 of a turn, using a spanner. The connection ring of the threaded connection can then no longer be removed from the sensor, and the immersion depth can therefore not be changed further.

The plastic cone is fitted to the separately available welded-on nozzle intended for this purpose, or to a suitable T-piece, using the union nut provided (available in brass or stainless steel). The union nut must be tightened to a torque of 20 Nm. It is possible to loosen the connection again, and so the immersion depth can be changed. This arrangement is suitable for pressures up to 10 bar.

When installing the push-in sensors, it should also be noted that the sensors are directional (comply with the marking on the housing).

For all types of installation, the reduction of the sensor tip must lie completely in the open flow cross-section, wherever possible at a depth of 1/3..1/2 of the pipe diameter. Run-in and run-out sections of 10 x D should be provided.

After installation, the OMNI head can be aligned in the best reading position, thanks to its rotatability.

**Programming**

The annular gap of the programming ring can be turned to positions 1 and 2. The following actions are possible:



**Set to 1 = continue (STEP)**  
**Set to 2 = modify (PROG)**

**Neutral position between 1 and 2**

The ring can be removed to act as a key, or turned through 180° and replaced to create a programming protector.

Operation is by dialog with the display messages, which makes its use very simple.

Starting from the normal display (currently measured value with unit), if 1 (STEP) is repeatedly selected, then the display shows the following information in this order:

**Display of the parameters, using position 1**

- Switching value S1 (switching point 1 in the selected unit)
- Switching characteristic of S1
- (MIN = monitoring of minimum value, hysteresis greater than switching value,

- MAX = monitoring of maximum value, hysteresis less than switching value)
- Hysteresis 1 (hysteresis value of S1 in the set unit)
- Switching value S2
- Switching characteristic of S2
- Hysteresis 2
- Code:
- After entering the code 111, further parameters can be defined
- Filter (settling time of the display and output)
- Units: e.g. l/min or %
- Output: 0..20 mA or 4..20 mA
- 0/4 mA (flow rate corresponding to 0/4 mA)
- 20 mA (flow rate corresponding to 20 mA)

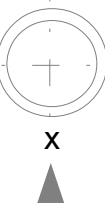

**Edit, using position 2**

If the currently visible parameter is to be modified:

- Turn the annular gap to position 2, so that a flashing cursor appears which displays the position which can be modified.
- By repeatedly turning to position 2, values are increased; by turning to position 1, the next digit is reached.
- Leave the parameter by turning to position 1 (until the cursor leaves the row); this accepts the modification.
- If there is no action within 30 seconds, the device returns to the normal display range without accepting the modification.

The limit switches S1 and S2 can be used to monitor minimal or maximal.

With a minimum-switch, falling below the limit value causes a switchover to the alarm state. Return to the normal state occurs when the limit value plus the set hysteresis is once more exceeded.

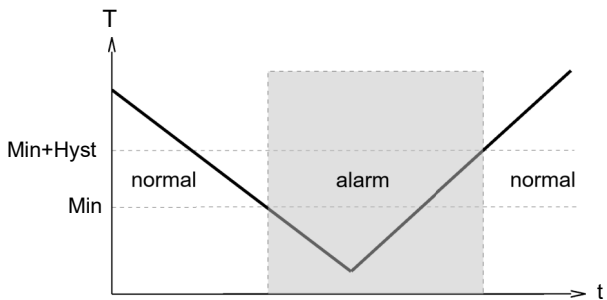

With a maximum-switch, exceeding the limit value causes a switchover to the alarm state. Return to the normal state occurs when the measured value once more falls below the limit value minus the set hysteresis.

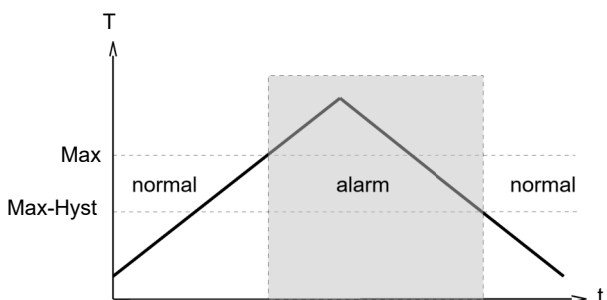

The change to the alarm state is indicated by the integrated red LED and a cleartext in the display.

While in the normal state the switching outputs are at the level of the supply voltage; in the alarm state they are at 0 V, so that a wire break would also display as an alarm state at the signal receiver.

**Overload display**

## Product Information

OMNI-F

Overload of the switching output is detected, indicated on the display ("Check S 1 / S 2"), and the switching output is switched off.

### Simulation mode

To simplify commissioning, the sensor supports a simulation mode for the analog output. It is possible to create a programmable value in the range 0..26.0 mA at the output (without modifying the process variable). This allows the wiring run between the sensor and the downstream electronics to be tested during commissioning. This is mode is accessed by means of **Code 311**.

### Factory settings

After modifying the configuration parameters, it is possible to reset them to the factory settings at any time using **Code 989**.

## Ordering code

OMNI-F-  1.  2.  3. **K** 4.  5.  6. **S** 7.

○=Option

1. Connection size						
008	connection G 1/4 A					
015	connection G 1/2 A					
013	system fastener Ø13.2					
012	push-in sensor Ø12					
2. Process connection						
H	male thread					• •
T	for insertion into the system T-piece					•
V	push-in sensor with variable insertion depth					•
3. Connection material						
K	stainless steel 1.4571					• • • •
4. Sensor						
028	sensor length	28.0 mm				•
029		29.6 mm				•
045		45.0 mm				•
031	sensor for T-piece	G 3/8..G 1/2				•
037		G 3/4..G 2				•
050	sensor length L	L=73				•
070		L=93				•
100		L=123				•
150		L=173				•
200		L=223				•
5. Analogue output						
I	Current output 0/4 – 20 mA					
U	○ Voltage output 0/2 – 10 V (available on request)					
6. Electrical connection						
S	for round plug connector M12x1, 5-pole					
7. Options 1						
H	○ model with gooseneck					

## Accessories

- ECI-1 device configurator (USB programming adapter)
- Cable / round plug connector (KB...) see additional information "Accessories"
- T-pieces for system connection Ø13.2
- Weld-on adapter for insertion sensor Ø12
- Compression fitting for insertion sensor Ø12
- Flange for insertion sensor Ø12