

Product Information

FLEX-F

Flow transmitter / switch FLEX-F



- Compact robust flow switch / transmitter
- Combination with temperature switch or transmitter possible
- No moving parts in the medium being monitored
- Only one medium-contact material
- Simple to use
- Very low pressure loss
- Various sensor lengths and models
- Short response times for a calorimetric sensor
- Cable outlet infinitely rotatable
- Small installation width, therefore very narrow pipework

Characteristics

The FLEX-F flow sensor monitors fluid media. Its compact form combines the built-in sensor and converter / counter which, depending on the model, trigger a limit value output (push-pull, compatible with PNP and NPN) or an analog output (4..20 mA or 0..10 V) or both. The limit switch can optionally also be operated as frequency output.

The converter / counter record two process parameters: the flow speed of the medium and its temperature. Both parameters can be assigned to the analog output or to the switching output. The following output combinations are available:

Flow		Temperature	
Analog output	Switching output	Analog output	Switching output
●			
	●		
●	●		
●			●
	●	●	

The switching output can be ordered as a minimum or a maximum switch.

Technical data

Sensor	calorimetric measurement principle	
Process connection	screw-in thread G 1/4 A..G 1/2 A, Push-in sensor Ø12 mm	
Metering range	water 2..150 cm/s or 3..300 cm/s oil available on request	
Measurement accuracy	depending on the installation location and flow conditions typically ±10 % of full scale value or 2 cm/s, measured in the T-piece ±5 % of full scale value	
Repeatability	±1 %	
Operating pressure	PN 100 bar, 200 bar available on request	
Metering range Temperature	0..+70 °C (high temperature model 0..+120 °C with gooseneck)	
Operating temperature	0..+70 °C	
Storage temperature	-20..+80 °C	
Temperature gradient	4 Kelvin/s	
Materials medium-contact	Sensor	1.4571
Materials, non-medium-contact	Housing	1.4305
	Plug	PA6.6
	Clip	PA6.6
Adjustment	by means of magnet	
Supply voltage	24 V DC ±10 %	
Current requirement	max. 100 mA	
Switching output	transistor output "push-pull" (resistant to short circuits and polarity reversal) I _{out} = 100 mA max.	
Switching hysteresis	flow 4 % of full scale value, temp.: approx. 2 °C	
Display	yellow LED (On = Normal / Off = Alarm / rapid flashing = Programming)	
Analog output	4..20 mA / Load 500 Ohm max. or 0..10 V	
Electrical connection	for round plug connector M12x1, 4-pole	
Weight	approx. 0.2 kg (standard version)	
Ingress protection	IP 67	
Conformity	CE	

Product Information

Signal output curves

Value x = Begin of the specified range
 = not specified range

Current output

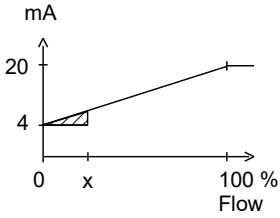

Voltage output

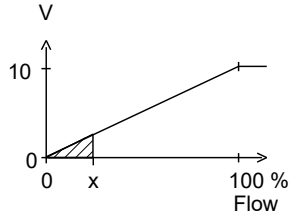

Frequency output

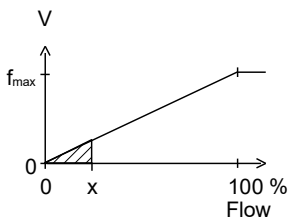

f_{max} selectable in the range of up to 2000 Hz

Other characters on request.

Wiring

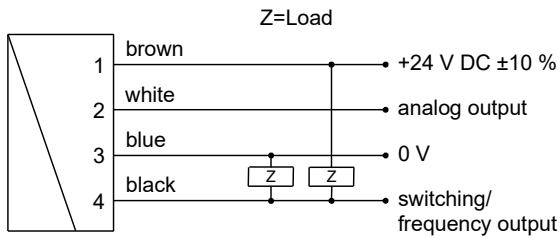

Connection example: PNP NPN

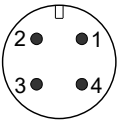

Dimensions

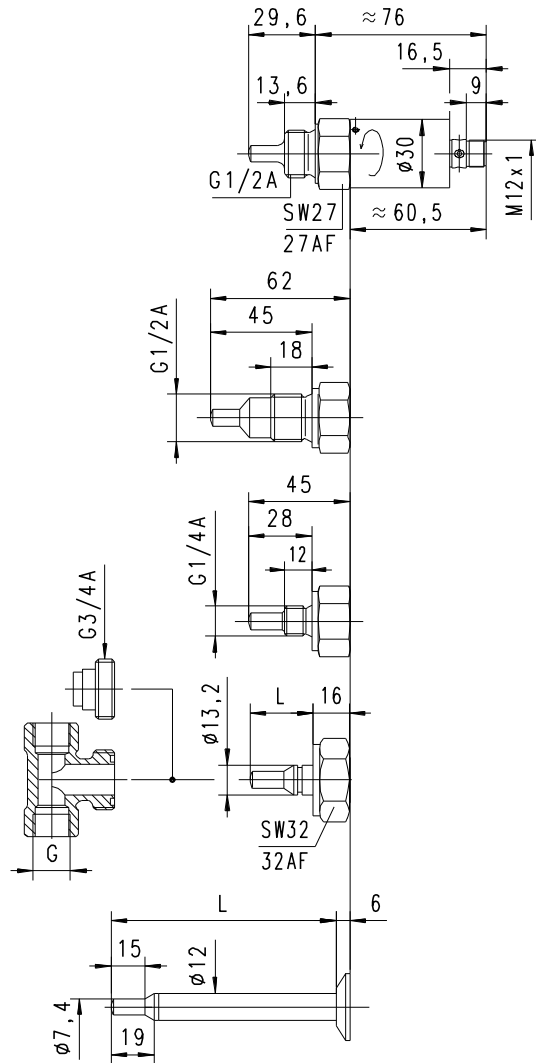

Product Information

Gooseneck option

A gooseneck (optional) between the electronics head and the primary sensor provides complete freedom in the orientation and reading direction of the sensor.

Handling and operation

Installation

Before the electrical installation, it must be ensured that the supply voltage corresponds with the data sheet.

In order to ensure the sensor's maximum insensitivity to interference, the flow should run from bottom to top (best degassing even at the slowest flow speed).

Screw-in sensors are to be sealed using Teflon tape, so that the inwards flow is directed to the incised cross. This is the position at which measurement is undertaken in the factory, and which guarantees the best results. The sensor must be screwed in using its hexagonal spanner only.

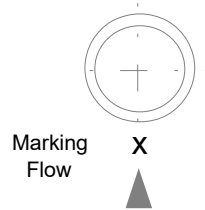

There are various options for installing the 12 mm push-in sensors (OMNI-F012):

The stainless steel crimp screw joints are screwed into a G 1/2 threaded drilling. For this, a G 1/2 welded-on nozzle is also available. When a suitable seal is used, this arrangement can take pressures up to 40 bar. The stainless steel threaded connection is first tightened by hand, and then by 1/4 of a turn, using a spanner. The connection ring of the threaded connection can then no longer be removed from the sensor, and the immersion depth can therefore not be changed further.

The plastic cone is fitted to the separately available welded-on nozzle intended for this purpose, or to a suitable T-piece, using the union nut provided (available in brass or stainless steel). The union nut must be tightened to a torque of 20 Nm. It is possible to loosen the connection again, and so the immersion depth can be changed. This arrangement is suitable for pressures up to 10 bar.

When installing the push-in sensors, it should also be noted that the sensors are directional (comply with the marking on the housing).

For all types of installation, the reduction of the sensor tip must lie completely in the open flow cross-section, wherever possible at a depth of 1/3...1/2 of the pipe diameter. Run-in and run-out sections of 10 x D should be provided.

Programming

The electronics contain a magnetic contact, with the aid of which different parameters can be programmed. Programming takes place when a magnet clip is applied for a period between 0.5 and 2 seconds to the marking located on the label. If the contact time is longer or shorter than this, no programming takes place (protection against external magnetic fields).



After the programming ("teaching"), the clip can either be left on the device, or removed to protect data.

The device has a yellow LED which flashes during the programming pulse. During operation, the LED serves as a status display for the switching output.

In order to avoid the need to transit to an undesired operating status during "teaching", the device can be provided ex-works with a "teach-offset". The "teach-offset" value is added to the currently measured value before saving (or is subtracted if a negative value is entered).

Example: The switching value is to be set to 70 % of the metering range, because at this flow rate a critical process status is to be notified. However, only 50% can be achieved without danger. In this case, the device would be ordered with a "teach-offset" of +20 %. At 50 % in the process, a switching value of 70 % would then be stored during "teaching".

Normally, programming is used to set the limit switch. However, if desired, other parameters such as the end value of the analog or frequency output may also be set.

The limit switch can be used to monitor minimal or maximal.

With a minimum-switch, falling below the limit value causes a switchover to the alarm state. Return to the normal state occurs when the limit value plus the set hysteresis is again exceeded.

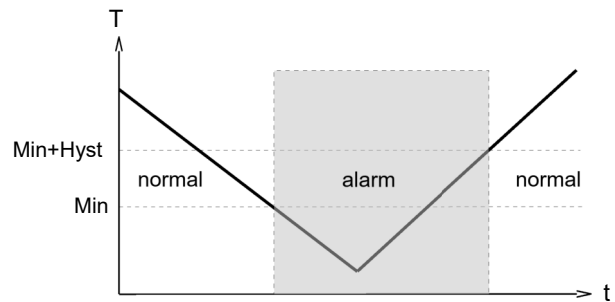

With a maximum-switch, exceeding the limit value causes a switchover to the alarm state. Return to the normal state occurs when the measured value once more falls below the limit value minus the set hysteresis.

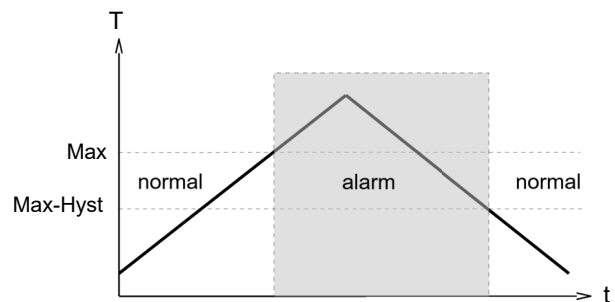

Product Information

FLEX-F

A switchover delay time (t_{DS}) can be applied to the switchover to the alarm state. Equally, one switch-back delay time (t_{DR}) of several can be applied to switching back to the normal state.

In the normal state the integrated LED is on, in the alarm state it is off, and this corresponds to its status when there is no supply voltage.

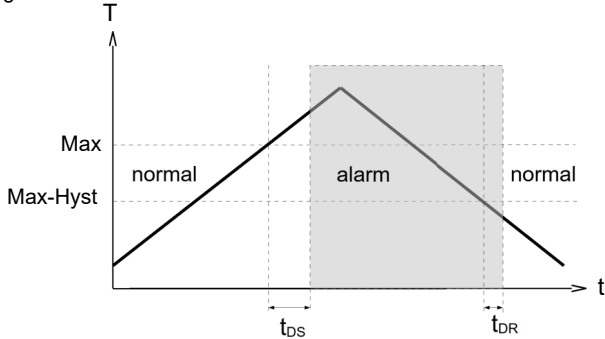

In the non-inverted (standard) model, while in the normal state the switching output is at the level of the supply voltage; in the alarm state it is at 0 V, so that a wire break would also display as an alarm state at the signal receiver. Optionally, an inverted switching output can also be provided, i.e. in the normal state the output is at 0 V, and in the alarm state it is at the level of the supply voltage.

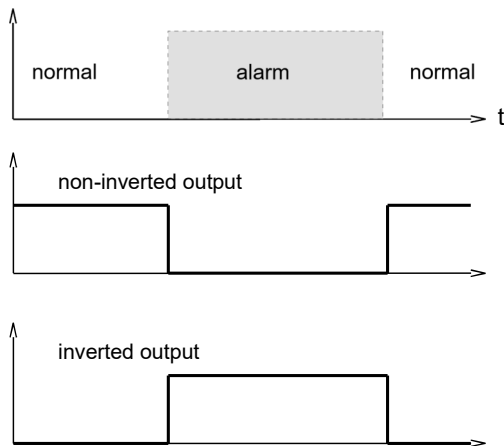

A Power-On delay function (ordered as a separate option) makes it possible to maintain the switching output in the normal state for a defined period after application of the supply voltage.

Ordering code

FLEX-F - 1. 2. 3. 4. 5. 6. 7. 8. 9. 10.

○=Option

1. Connection size									
008	connection G 1/4 A								
015	connection G 1/2 A								
013	system fastener Ø13.2								
012	push-in sensor Ø12								
2. Process connection									
H	male thread								• •
T	for insertion into the system T-piece								•
V	push-in sensor with variable insertion depth								•
3. Connection material									
K	stainless steel 1.4571								• • • •
4. Sensor									
028		28.0 mm							•
029	sensor length	29.6 mm							•
045		45.0 mm							•
031	sensor for T-piece	G 3/8..G 1/2							•
037		G 3/4..G 2							•
050	insertion sensor	50 mm							•
070		70 mm							•
100		100 mm							•
150		150 mm							•
200		200 mm							•
5. Analog output									
I	current output 4..20 mA								
U	○ Voltage output 0..10 V								
K	without analog output								
6. Unit for analog output									
F	flow rate to analog output								
T	○ temperature to analog output								
K	without analog output								
7. Switching output									
T	switching output push-pull								
M	○ switching output NPN (open collector)								
K	without switching output								
8. Measurement parameter to switching output									
F	flow to switching output								
T	○ temperature to switching output								
K	without switching output								
9. Function for switching output									
L	minimum switch								
H	maximum switch								
R	○ frequency output								
10. Switching output level									
O	standard output								
I	○ inverted output								

Product Information

FLEX-F

Options

Special measuring range for flow: cm/s
 Max. 300 cm/s (standard = 150 cm/s)

Special measuring range for temperature: °C
 Maximum 120 °C (standard = 70 °C)

Minimum -20 °C (standard = 0 °C) °C

Special range for analog output: cm/s
 <= Metering range (standard = metering range) °C

Special range for frequency output: cm/s
 <= Metering range (Standard = Metering range) °C

End frequency (max. 2000 Hz) Hz

Switching delay s
 (from Normal to Alarm)

Switchback delay s
 (from Alarm to Normal)

Power-On delay (0..99 s) s
 (time after power on, during which the outputs are not actuated)

Switching output fixed cm/s
 °C

Special hysteresis (standard = 4 % EW) %

Gooseneck
 (recommended at operating temperatures above 70 °C)

If the field is not completed, the standard setting is selected automatically.

Accessories

- Device configurator ECI-1
- T-pieces for system connection Ø13.2
- Weld-on adapter for insertion sensor Ø12
- Compression fitting for insertion sensor Ø12
- Flange for insertion sensor Ø12
- Cable/round plug connector (KB...)
 see additional information "Accessories"