

Operating manual

Temperature limiter/
Temperature monitor

TB225

Approved in accordance with:

DIN EN 14597 (replacing DIN 3440)
SIL 2 (optional)



Option:



Company / brands of GHM

Members of GHM GROUP:

GREISINGER
HONSBERG
Martens
IMTRON
DeltaGHM
VAL.CO

www.ghm-group.de

Translation of the original German version. In questions of technical incorrectness or wrong translations, please refer to the german version.

Save for later reference.

- 1 Intended use (areas of application)..... 3
 - 1.1 Safety signs and symbols 3
 - 1.2 Safety instructions..... 4
 - 1.3 Product liability and warranty 4
 - 1.4 Standards and directives 4
 - 1.5 Approvals 4
- 2 Product description 5
 - 2.1 Scope of delivery 5
 - 2.2 Functional principle 5
 - 2.3 Layout of the measuring system 6
- 3 Assembly and installation 7
 - 3.1 Mechanical assembly..... 7
 - 3.2 Electrical installation 8
 - 3.3 Connection diagram..... 9
- 4 Controls and functional description..... 10
 - 4.1 Basic operation of the TB225..... 10
 - 4.2 Menu structure and parameter overview..... 12
 - 4.3 Display menu 13
 - 4.4 Input menu..... 16
 - 4.5 Output menu 18
 - 4.6 Function menu 22
 - 4.7 Error messages..... 25
- 5 Functional Safety 26
- 6 Function Test..... 27
- 7 Commissioning, maintenance and service 28
 - 7.1 Commissioning 28
 - 7.2 Maintenance 28
 - 7.3 Service..... 28
- 8 Technical data 29
 - 8.1 Mechanical design / dimensions 30
- 9 Order code..... 31
 - 9.1 Accessories..... 31
 - 9.2 Troubleshooting 31
- 10 Device transport and storage..... 31
- 11 Returns 32
- 12 Disposal..... 32
- 13 Imprint..... 32
- 14 EC Certificate of Conformity 33

1 Intended use (areas of application)



Refer to the chapter 'Product description' for detailed specifications for the area of application.

The operational safety of the device is only assured when used as intended in accordance with the specifications in the operating manual.

Intervention beyond the actions described in the operating manual may only be carried out by personnel authorized by the manufacturer for safety and warranty reasons. Conversions or modifications made on one's own authority are expressly prohibited.

Application-specific dangers can emanate from this device when used improperly or not as intended.



In the event of improper use, this device may pose application-specific hazards.

The device is not suitable for use in potentially explosive atmospheres.

The device is only suitable for use in safety-relevant systems according to SIL with the option -SIL chosen by ordering code.

General safety instructions, use

This operating manual must be kept in a location such that qualified personnel can refer to it at all times.

Any processes described in this operating manual may only be carried out by trained, qualified personnel who are authorized by the owner and wearing protective clothing. All rights reserved.

1.1 Safety signs and symbols

Warning notices are identified in this document as described under Table 1:



Warning

Warning! This symbol warns of imminent danger which can result in death, severe bodily injury, or severe property damage in case of non-observance.



Attention! This symbol warns of potential dangers or harmful situations which can cause damage to the device or to the environment in case of non-observance.



Note! This symbol indicates processes which can have a direct influence on operation or can trigger an unforeseen reaction in case of non-observance.



Warning! of an area in which explosive atmospheres can form. This only applies to devices with ATEX approval.

1.2 Safety instructions

Read the product description before commissioning the device. Ensure that there are no limitations for use of the product for the relevant applications.



The owner is responsible for ensuring the fault-free operation of the device. The owner is obligated to ensure compliance and to observe the required work and safety measures of the current applicable regulations for the entire duration of use.

1.3 Product liability and warranty

Exclusion of liability:

The contents of the operating manual have been checked to ensure conformity with the described device. However, deviations cannot be entirely ruled out. Therefore, we cannot assume any guarantee for complete conformity. The specifications in this document are checked regularly and any necessary corrections are incorporated into subsequent versions. This document is subject to technical changes. In addition, all claims are based on the valid 'Standard Terms for the Supply of Products and Services of the Electrical Industry'.



GHM Messtechnik GmbH cannot inspect or repair any devices without the required form having been filled in completely (refer to page 32 'Returns').

1.4 Standards and directives

Conformity with Directive 2014/30/EU

CE Conformity	EN 60730-1:	2011
	EN 60730-2-9:	2010

Installation Category 3 for equipment of Overvoltage Category III according to IEC 61000-4-5.

1.5 Approvals

EN 14597: 2012	Temperature control devices and temperature limiters for heat generating systems
----------------	--

EN 61508:2010	Functional safety of electrical/electronic/programmable electronic safety-related system
---------------	--

2 Product description

The present processor-controlled, independently installed electronic regulating and control device for control panel assembly is designed for the monitoring of thermal processes and the safe control thereof in the event of an error. The device has universal inputs to which double thermocouples, PT100 sensors and unit signals (0/4 ... 20mA and/or 0/2 ... 10V) can be connected. The safety function is provided by means of the main relay with configurable threshold. An additional relay with an independently adjustable threshold is provided for additional signaling. In addition, it offers an analogue output which can be freely defined within the measuring range of the temperature input. The resetting of the device in the operating mode as a temperature limiter (TB) can take place via the buttons on the front, the integrated graphic display, or using an external switch or external voltage.

2.1 Scope of delivery

- TB225
- this operating manual
- further documents, if applicable

2.2 Functional principle

The connected temperature signal is evaluated and monitored. If the permissible threshold is reached or an error occurs within the permissible temperature range (sensor break, sensor short-circuit, failure of a component in the device, error in the software, failure of auxiliary voltage), the TB225 switches off immediately.

The additional relay output of the TB225 enables the function of a preliminary alarm with an independent threshold.

The following operating modes are possible through configuration:

Temperature limiter (TB):

Maximum or minimum monitoring with catch

Manual resetting after fault elimination via the front keys or an external switch / voltage signal

Operating methods in accordance with EN14597: 09/2012: Type 2B, 2H, 2V

Temperature monitor (TW):

Maximum or minimum monitoring without catch

Automatic resetting on return to the permissible range

Operating methods in accordance with EN14597: 09/2012: Type 2B

2.3 Layout of the measuring system

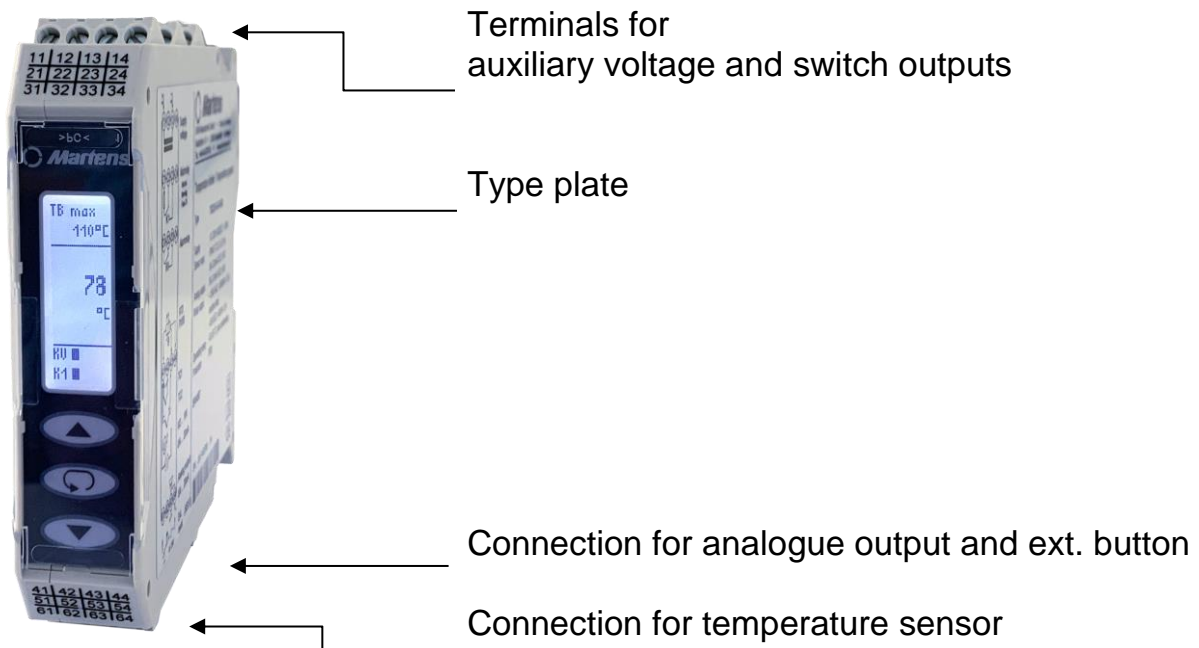

Fig. 1: Temperature limiter TB225

Block circuit diagram

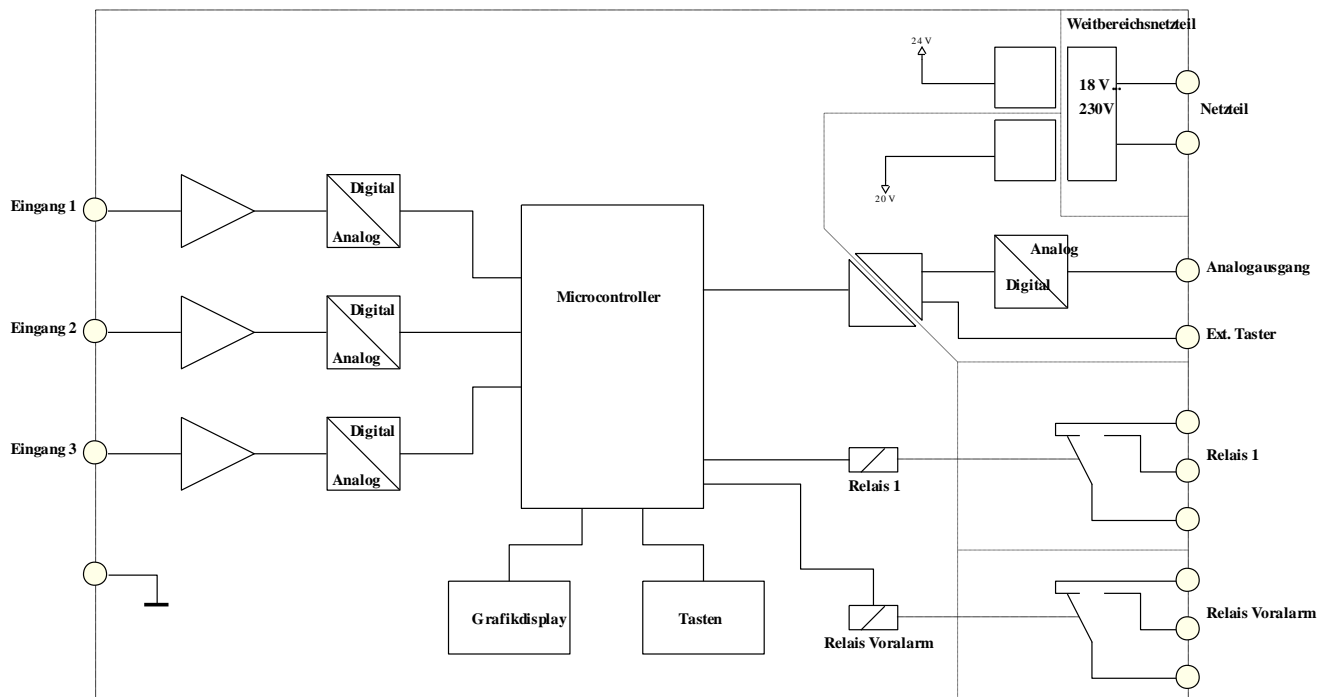

Fig. 2: Block circuit diagram

Type plate

The type plate includes the most important identification data

- Type and article name
- Technical data
- Serial number / bar code

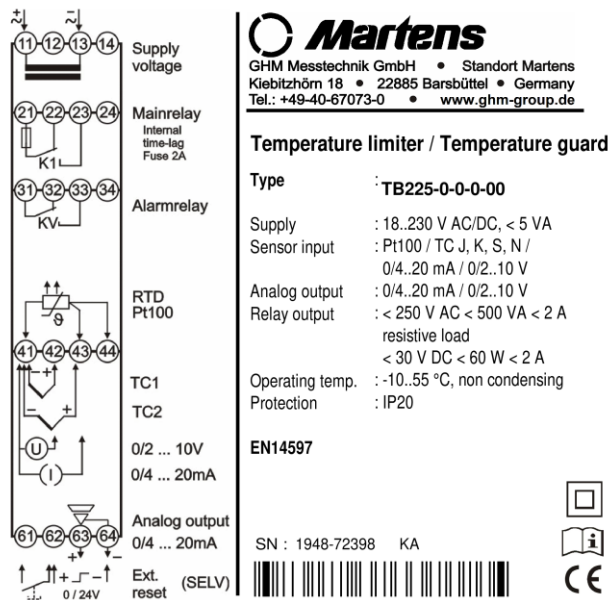

Fig. 3: Type plate

3 Assembly and installation

3.1 Mechanical assembly

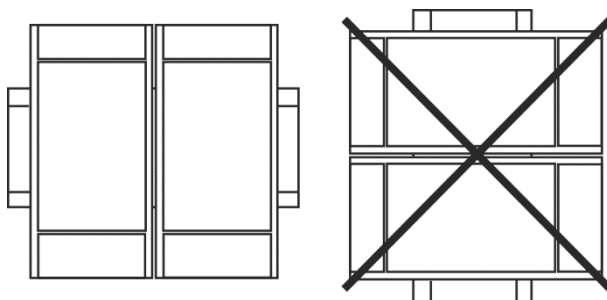

Fig. 4

Carrier rail mounting TS35, DIN EN 60715

The mounting of multiple devices without spaces is only permitted on horizontally mounted carrier rails.

3.2 Electrical installation



The device may only be installed by an electrician. The national and international regulations for connection of electrical systems in the respective user country apply.

The auxiliary voltage is connected at Connections 11 and 13 of the plug-in terminal strip. Terminals 41-44 are for the universal inputs of the TB225.

The 2 switch outputs are available at Connections 21-23 (main relay) and 31-33 (alarm relay). The active analogue output is provided at Terminals 63 and 64; it switches between current and voltage signal depending on the resistance.

For the external resetting of the TB225 in temperature limiting mode, a potential-free button can be connected to Terminals 61 and 62 or a voltage signal can be connected to Terminals 62 and 64.

3.3 Connection diagram

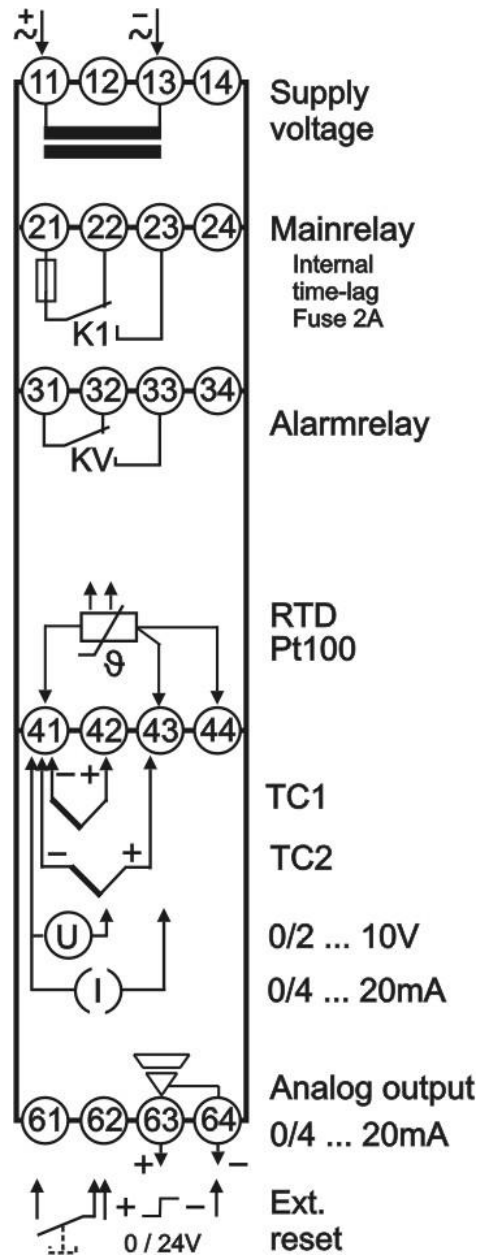

Fig. 5: Connection

4 Controls and functional description

The parameterisation of the temperature limiter / temperature monitor TB225 takes place via the 3 capacitive buttons on the front side of the device.

You must lift your finger of the button after pressing it each time!!

4.1 Basic operation of the TB225

The **Operating level** is displayed first after the TB225 is switched on.

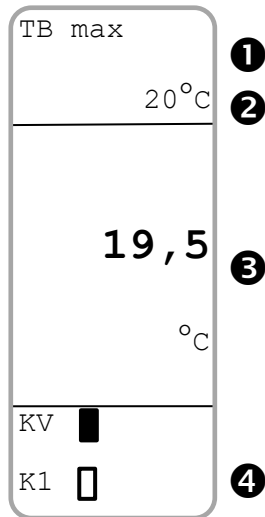

Along with the **operating mode** ❶, the operating level provides information about the **threshold of the safety function** ❷ as well as the measured **temperature** ❸ and the **status of the switch outputs** ❹

Status of the switch outputs

KV (□) = alarm relay not activated

K1 (■) = main relay activated

Fig. 6 Operating level

The Reset menu (Fig. 7a and 7b) and the peak value buffer (Fig. 8) can be opened by briefly pressing the middle button. For a reset, the upper arrow key must be pressed until the bar has reached its full length.



Fig. 7a

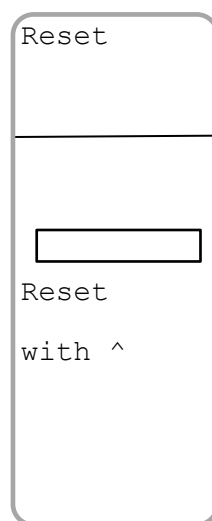

Fig. 7b

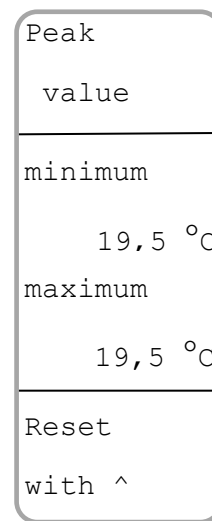

Fig. 8

Press the centre button for 2 seconds in the operating level in order to reach the **main menu**. All the parameters that determine the characteristics of the device are programmed here. Selection takes place with the arrow keys, wherein the currently selected menu item has a black background. The actuated selection is opened by pressing the centre button. The 'back' parameter takes you back up one level.

If no buttons are pressed for 2 minutes, the system automatically returns to the operating level. By pressing the middle button for 2 seconds, you can also exit the menu again.

The **main menu** is divided into the following submenus:

- Back
- Display
- Input
- Output
- Funktion

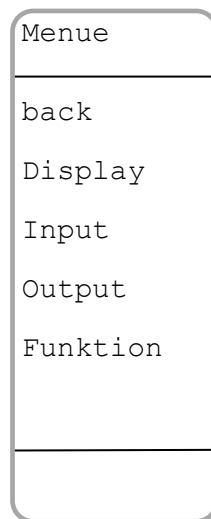

Fig. 9: Main menu

4.2 Menu structure and parameter overview

The device operation is menu-based. The individual menus are explained in greater detail in the following sections.

4.2.1 List of parameters

The following table shows the menu structure of the TB225.

1. Menu level	2. Menu level	Editing level	
	Parameter	Selection / input	Unit
1 - Display	1.1 - Back	Jump to 1st Menu level	
	1.2 - Unit	Selection	
	1.3 - Contrast	Number input	%
	1.4 - Language	Selection	
	1.5 - Lighting	Selection	
	1.6 - Decimal place	Selection	
2 - Input	2.1 - Back	Jump to 1st Menu level	
	2.2 - Signal	Selection	
	2.3 - Start analogue input	Number input	°C / °F
	2.4 - End analogue input	Number input	°C / °F
3 - Output	3.1 - Back	Jump to 1st Menu level	
	3.2 - Analogue	Selection	
	3.3 - Start analogue output	Number input	°C / °F
	3.4 - End analogue output	Number input	°C / °F
	3.5 - Analogue output error	Selection	
	3.6 - Alarm - relay	Selection	
	3.7 - Alarm - value	Number input	°C / °F
	3.8 - Alarm - hysteresis	Number input	°C / °F
4 - Function	4.1 - Back	Jump to 1st Menu level	
	4.2 - Operating mode	Selection	
	4.3 - Threshold	Number input	°C / °F
	4.4 - Hysteresis	Number input	°C / °F
	4.5 - External button function	Selection	
	4.6 - Temperature correction	Number input	°C / °F
	4.7 - Temperature difference	Number input	°C / °F

Table 1

4.3 Display menu

The **Display** menu is divided into the following parameters:

- Back
- Unit
- Contrast
- Language
- Lighting
- Decimal place

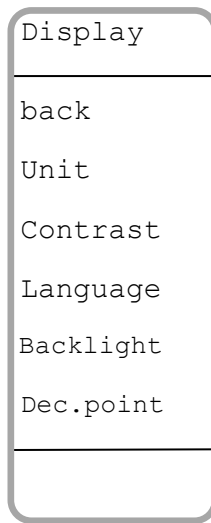

Fig. 10: Display menu

4.3.1 Display menu – Unit parameter

The temperature unit (°C or °F) is specified with the **Unit** parameter.

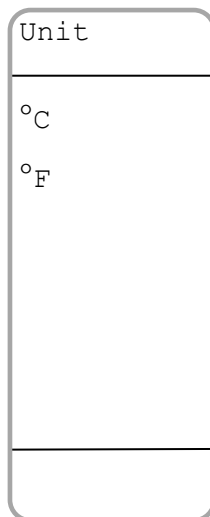

Fig. 11: Unit parameter

4.3.2 Display menu – Contrast parameter

The **Contrast** parameter specifies the contrast setting of the display with a percentage between 0 and 100%.

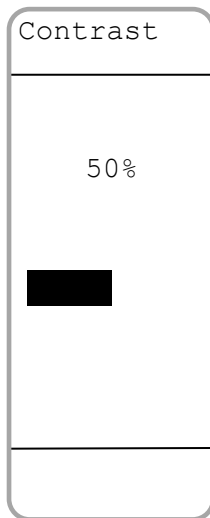

Fig. 12: Contrast parameter

4.3.3 Display menu – Language parameter

The **Language** parameter specifies the display language.

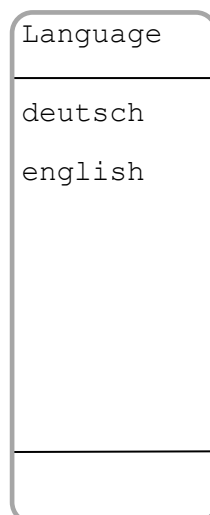

Fig. 13: Language parameter

4.3.4 Display menu – Lighting parameter

The display **lighting** is set with the Lighting parameter.

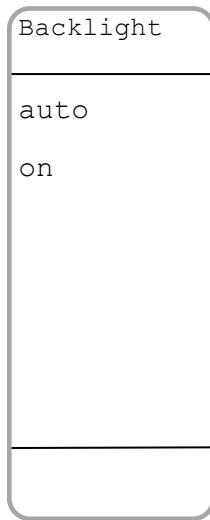

Fig. 14: Lighting parameter

Auto: The display lighting is automatically deactivated after 2 min. if the device is not operated.

On: The display lighting is permanently activated.

4.3.5 Display menu – Decimal place parameter

The decimal place parameter specifies whether the temperature is displayed with or without a decimal place.

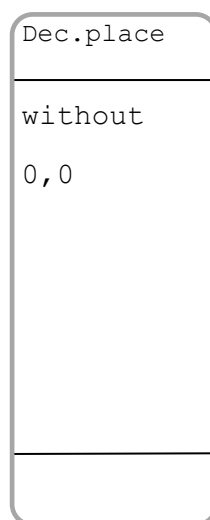

Fig. 15: Decimal place parameter

without	no decimal place
0.0	one decimal place

4.4 Input menu

The **Input** menu is divided into the following parameters:

- Back
- Signal
- Analogue input start value
- Analogue input end value

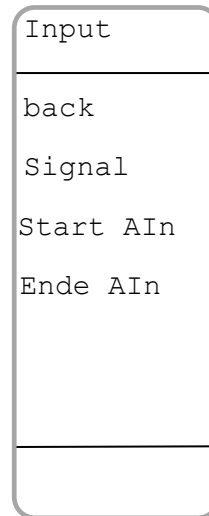

Fig. 16: Input menu

4.4.1 Input menu - Signal parameter

The **Signal** parameter defines the input signal of the TB225.

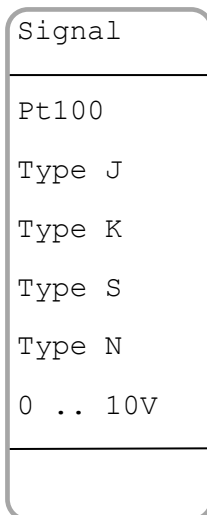



Fig. 17: Signal parameter

PT100	Pt100 in 3-conductor circuit	
Type J	Double thermocouple Fe-CuNi	
Type K	Double thermocouple NiCr-Ni	
Type S	Double thermocouple Pt10Rh-Pt	
Type N	Double thermocouple NiCrSi-NiSi	
0..10V	Analogue input 0..10V	
2..10V	Analogue input 2..10V	
0..20mA	Analogue input 0..20mA	
4..20mA	Analogue input 4..20mA	



Warning

0...10 V and 0...20 mA must not be selected if device acts as temperature limiter!



Warning

0...10 V and 0...20 mA must not be selected if device actes in safety relevant application acc. to SIL!

4.4.2 Input menu - Analogue input start value parameter

The **Analogue input start value** parameter is used to define the temperature, which is assigned to the lower analogue value (0/2V and/or 0/4mA).

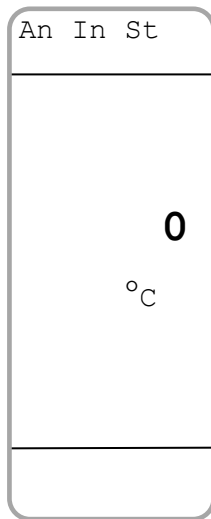

Fig. 18: Analogue input start value parameter

4.4.3 Input menu - Analogue input end value parameter

The Analogue input end value parameter is used to define the temperature, which is assigned to the upper analogue value (10V and/or 20mA).

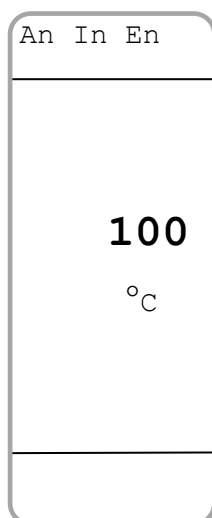

Fig. 19: Analogue input end value parameter

4.5 Output menu

The **Output** menu is divided into the following parameters:

- Back
- Analogue output
- Start value scaling
- End value scaling
- Error behaviour analogue output
- Function alarm relay
- Alarm value
- Alarm hysteresis

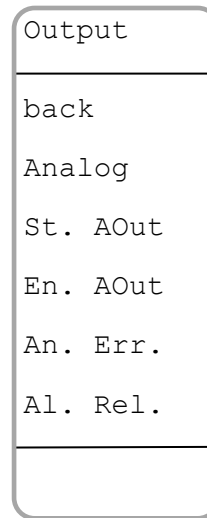

Fig. 20: Output menu

4.5.1 Output menu - Analogue output parameter

The **Analogue output** parameter defines the control range of the analogue output.

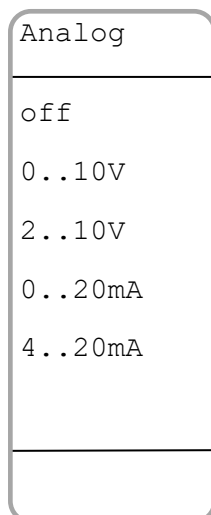

Fig. 21: Analogue output parameter

4.5.2 Output menu - Scaling start value parameter

This parameter defines the corresponding temperature value at which 0/2V and/or 0/4mA is output at the analogue output

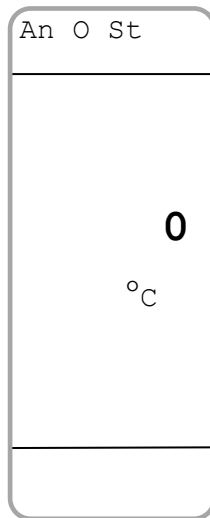

Fig. 22: Scaling end value parameter

4.5.3 Output menu - Scaling end value parameter

This parameter defines the corresponding temperature value at which 10V and/or 20mA is output at the analogue output.

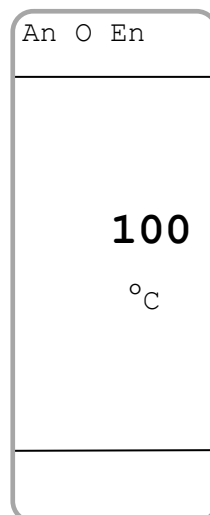

Fig. 23: Scaling end value parameter

4.5.4 Output menu – Analogue output error behaviour

Defines the behavior of the analogue output when a value is exceeded or undercut, insofar as there are errors in the input.

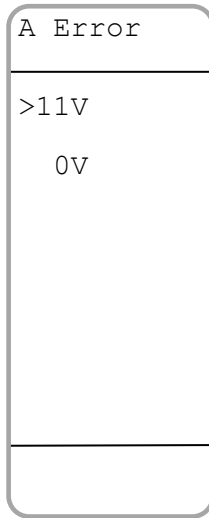

Fig. 24: Analogue output error behaviour

Analogue output setting	Error behavior selection
0 ... 20mA	> 22mA
	0mA
4 ... 20mA	> 22mA
	<3.6mA
0 ... 10V	> 11V
	0V
2 ... 10V	> 11V
	< 1,8V

4.5.5 Output menu – Alarm relay function parameter

This parameter is used for the setting of the alarm relay function.

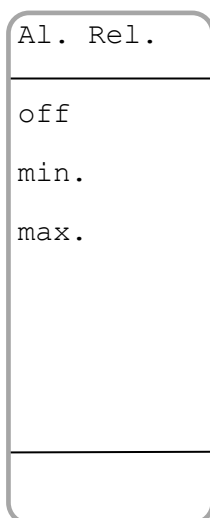

Fig. 25: Alarm relay function parameter

off	Alarm relay permanently deactivated
min	Alarm relay is deactivated when the adjusted alarm value is undercut
max	Alarm relay is deactivated when the adjusted alarm value is exceeded

4.5.6 Output menu – Alarm value parameter

The **Alarm value** parameter specifies the switching point of the alarm relay.

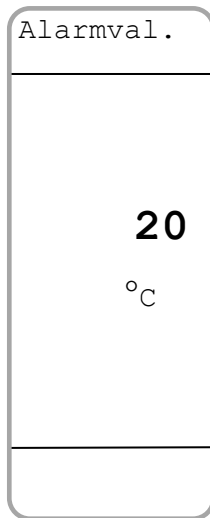

Fig. 26: Alarm value parameter

4.5.7 Output menu – Alarm hysteresis parameter

The **Alarm hysteresis** parameter specifies the switching hysteresis of the alarm relay.

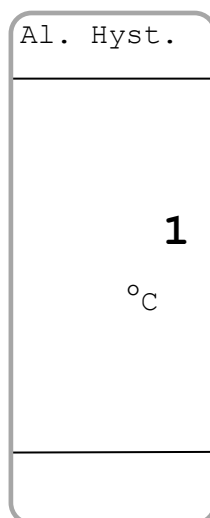

Fig. 27: Alarm hysteresis parameter

4.6 Function menu

The **Function** menu is divided into the following parameters.

- Back
- Operating mode
- Limit value
- Hysteresis
- External button function
- Temperature correction
- Temperature difference
(only with thermocouples)

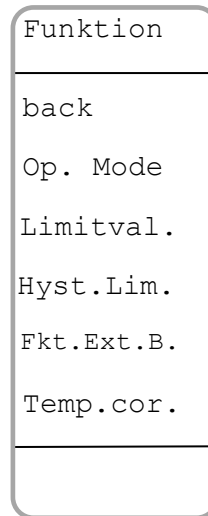

Fig. 28: Function menu

4.6.1 Function menu – Operating mode parameter

The **Operating mode** parameter sets the desired operating mode:

Op. mode	TB max	Temperature limiter, maximum monitor
TB max	TB min	Temperature limiter, minimum monitor
TB min	TW max	Temperature monitor, maximum monitor
TW max	TW min	Temperature monitor, minimum monitor
TW min		

Fig. 29:
Parameter
Operating mode

- Maximum monitor: Relay is deactivated when the adjusted threshold is exceeded
- Minimum monitor: Relay is deactivated when the adjusted threshold is undercut

4.6.2 Function menu – Threshold parameter

The **Threshold** of the safety function is set with this parameter.

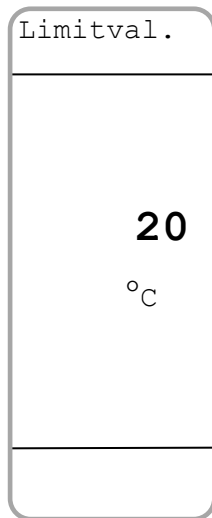

Fig. 30: Threshold parameter

4.6.3 Function menu – Hysteresis parameter

The **Hysteresis (switching difference)** of the threshold of the safety function is set here.

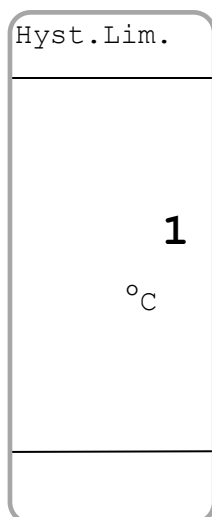

Fig. 31: Hysteresis parameter

4.6.4 Function menu – External button function parameter

The connection possibilities of Terminal 61 and 62 can be selected under the **External button function** parameter.

Fkt.Ext.T.	off	No function at Terminal 61/62
off	Reset	Reset in temperature limiter operating mode
Reset	Keylock	Block of the entire button operation
Keylock	Parameter lock	Block of the menu level; only the operating level can be operated.
Para.lock		

Fig. 32: External button function parameter

4.6.5 Function menu – Temperature correction parameter

An error of the measuring sensor can be corrected with this parameter.

Temp.cor.
<div style="font-size: 2em; font-weight: bold; margin: 0;">0</div> <div style="margin: 0;">°C</div>

Fig. 33: Temperature correction parameters

4.6.6 Function menu – Temperature difference

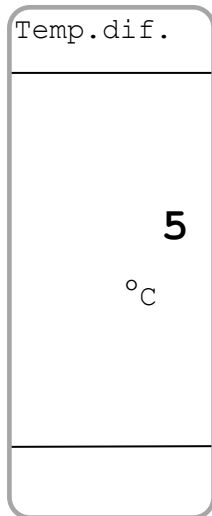

The maximum difference between the two thermocouples that does not lead to an error shut-down can be adjusted with the temperature difference parameter.

Fig. 34: Temperature difference parameter

4.7 Error messages

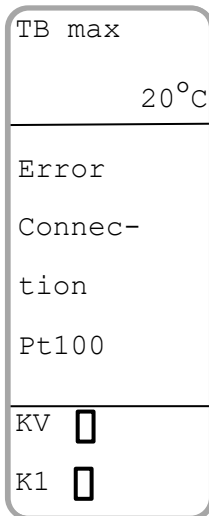

Overview of possible error messages:

Error message	Remedy
Connection Pt100	Check the sensor connection
Short circuit Pt100	Check the sensor connection
Line resistance exceeded	Check the sensor connection
Internal Pt100	An error has occurred in the device, please send the device to the manufacturer.
Connection TC	Check the sensor connection
Difference TC	Check the sensor connection
I In too high	Check the input current
I In too low	Check the input current
U In too high	Check the input voltage
U In too low	Check the input voltage
Internal voltage	An error has occurred in the device, please send the device to the manufacturer.

Fig. 35: Error message

5 Functional Safety

The temperature limiter TB225 was developed according to the specifications of IEC 61508. This standard describes the functional safety of safety-related programmable electrical and electronic systems.

The device corresponds to a class B subsystem with a requirement level of SIL2 (single-channel). The safety function of the device refers to measurement and evaluation of the temperature and the resulting contact position of the built-in relay.

Safe Condition

The safe condition of the device is given only in the resting position of the main relay (current principle). If the internal diagnostic system detects an error, the main relay assumes the resting position. For the integration of the relay changer into the monitoring system, therefore the closing contact must be used.

Temperature Sensor

Connected temperature sensors are monitored for open circuit or short circuit. In the case of using thermocouples, this is physically only possible with double thermocouples. It is not permitted to use single thermocouples and set the inputs parallel by wire bridges. If separate sensor fittings are used, they must be mounted directly next to each other so that both can reach the same temperature.

Fault and Error

If there is an accident at the plant, the cause must be eliminated immediately. If the temperature limiter TB225 is decommissioned, the process must be secured in a different way. If there is a device error, we kindly ask you to send it to the factory with a short description of the error.

Safety key figures for functional safety TB225					
Attention: Only for the device variant with SIL approval!					
Safety-related output signal	relay output				
Test standard	IEC 61508				
Testing laboratory	TÜV NORD CERT GmbH				
Safety integrity	SIL 2				
System	Typ B				
		Input			
		Pt100	Thermocouple	4 .. 20mA	2 .. 10V
λ_{SD}	(Rate of detected safe failures)	88 FIT	73 FIT	71 FIT	71 FIT
λ_{SU}	(Rate of undetected safe failures)	524 FIT	486 FIT	505 FIT	506 FIT
λ_{DD}	(Rate of detected dangerous failures)	325 FIT	311 FIT	279 FIT	279 FIT
λ_{DU}	(Rate of undetected dangerous failures)	658 FIT	606 FIT	620 FIT	620 FIT
		(1 FIT = 1 failure / 10 ⁹ h)			
Average probability of failure on demand (PFD _{avg})		6,46 x 10 ⁻³	3,95 x 10 ⁻³	4,81 x 10 ⁻³	4,78 x 10 ⁻³
Probability of failure per hour (PFH)		1,55 x 10 ⁻⁷	9,81 x 10 ⁻⁸	1,18 x 10 ⁻⁷	1,17 x 10 ⁻⁷
Useful life of the safety function		10 years	10 years	10 years	10 years

6 Function Test

When operating the device at a high request rate, i.e. in the event of process-related frequent response to the device, additional functional tests can be dispensed with in accordance with IEC 61508. This also applies to operation with a low request rate, i.e. in case of process-related rare response of the device. The probability of failure is very low for 10 years of service according to SIL2 (see table on page 26).

For a functional test, the temperature sensor / current / voltage is simulated with a simulator. In the case of thermocouples, the inputs may be connected in parallel.

The test starts with the check of the temperature monitoring. In the good area, the relay must be active.

It is then tested

- the consistency of the temperature displayed on the TB225 display with that of the simulator at each test step
- the alarm function when leaving the good area of the temperature
- the alarm function in case of sensor breakage (each line disconnected) and sensor short circuit.

A correct alarm function of the TB225 is given when

- the relay is deactivated and the contact takes the resting position,
- the respective error in the display is displayed correctly as plain text,
- the display lighting of the TB225 changes to "red",

After the temperature has been changed back to the good range with the simulator, a correct function of the TB225 is given when in the operating mode temperature limiter

- the relay is only activated again after a reset has been made in the menu or a external RESET button has been pressed,
- after which the display shows the normal operating data,
- the display lighting of the TB225 switches back to "white",

if in the operating mode temperature monitors

- the relay is activated without a reset in the menu or an external RESET button being pressed,
- the display shows the normal operating values,
- the display illumination of the TB225 changes back to "white";



Warning!

If the relay is not deactivated during one of the test steps, or the temperature or fault rate is not displayed correctly in the display, the TB225 must be sent to the factory for inspection.

In the meantime, the plant must be kept in a safe condition by other means.



Special Note!

- The temperature limiter TB225 must be used in a control cabinet with a degree of protection of at least IP40.
- A strain relief of the connection line(s) from the temperature sensor shall be provided.
- To protect the internal device protection of the TB225, it is recommended to secure the monitoring circuit with an external fuse (maximum 1.6 A medium inert). When the internal fuse is detached, the device must be sent to the factory for repairs!

7 Commissioning, maintenance and service

7.1 Commissioning

1. Ensure that the connection assignment takes place according to the connection diagram and matches the auxiliary voltage.
2. Ensure that the terminals are firmly screwed in.
3. After switching on the auxiliary energy, check for the correct switching function.

7.2 Maintenance

Housing:

No cleaning or maintenance is required when operated as intended.

7.3 Service



Service of the device is only possible at the factory.

8 Technical data

Auxiliary energy			
Auxiliary voltage:	18...230 V AC/DC		
Power consumption:	< 5 VA		
Rated voltage:	250V AC according to EN 60730-1: 2011, between input / relay output / auxiliary voltage, Degree of Contamination 2, Overvoltage Category III Rated surge voltage 4kV		
CE Conformity: 2014/30/EU 2014/35/EU 2011/65/EU	EN 60730-1: 2011, EN 60730-2-9: 2010 EN 60664-1: 2007 EN IEC 63000: 2018		
Environmental conditions			
Working temperature:	-10..+55 °C		
Storage temperature:	-20..+60 °C		
Relative air humidity:	< 95 %		
Condensation:	not permitted		
Approvals			
EN 14597: 2012	Temperature control devices and temperature limiters for heat generating systems		
EN 61508: 2010	Functional safety of electrical/electronic/programmable electronic safety-related system		
Input			
PT100:	-100,0 ... 600,0, 3-conductor circuit, Sensor current <1mA (no self-heating)		
Basic precision:	0.2 %, ± 1 Digit		
Temperature coefficient:	0.01 %/K		
Thermocouple:	Type J	Fe- CuNi	-100 ... 800°C
	Type K	NiCr-Ni	-150 ... 1200°C
	Type N	NiCrSi-NiSi	-150 ... 1200°C
	Type S	Pt10RH-PT	0 ... 1600°C
	Integrated comparison position compensation		
Basic precision:	0.3%, ± 1 Digit		
Temperature coefficient::	0.01 %/K		
Analogue input:	0/2 .. 10V 0/4 .. 20mA	0..10V and 0..20mA not permitted for temperature limiting!	
Basic precision:	0.2 %, ± 1 Digit		
Temperature coefficient:	0.01 %/K		
Output			
Switching outputs:	2 x relay		
Changeover relays:	< 250 V AC < 500 VA < 2 A ohmic load < 30 V DC < 60W < 2 A ohmic load		
Internal main relay secured with 2A slow-blow fuse! Fuse is not interchangeable!			
Analogue output:	0/4..20 mA resistance ≤ 500 Ω 0/2..10 V DC resistance > 500 Ω galv. iso. Output switches automatically (resistance-dependent)		
Basic precision:	0.2 %		
Temperature coefficient:	0.01 %/K		
display			
	Graphic LC display with 32 x 90 pixels, with white-red background lighting		
Casing			
Material:	Polyamide (PA) 6.6 , UL94V-0 Carrier rail mounting TS35 DIN EN 60715		
Weight:	approx. 400 g		
Electrical connection:	Plug-in screw terminals with wire guard, 0.14..2.5 mm ² (AWG 26..14)		
Protection type			
	IP20 BGV A3		

Table 2

8.1 Mechanical design / dimensions

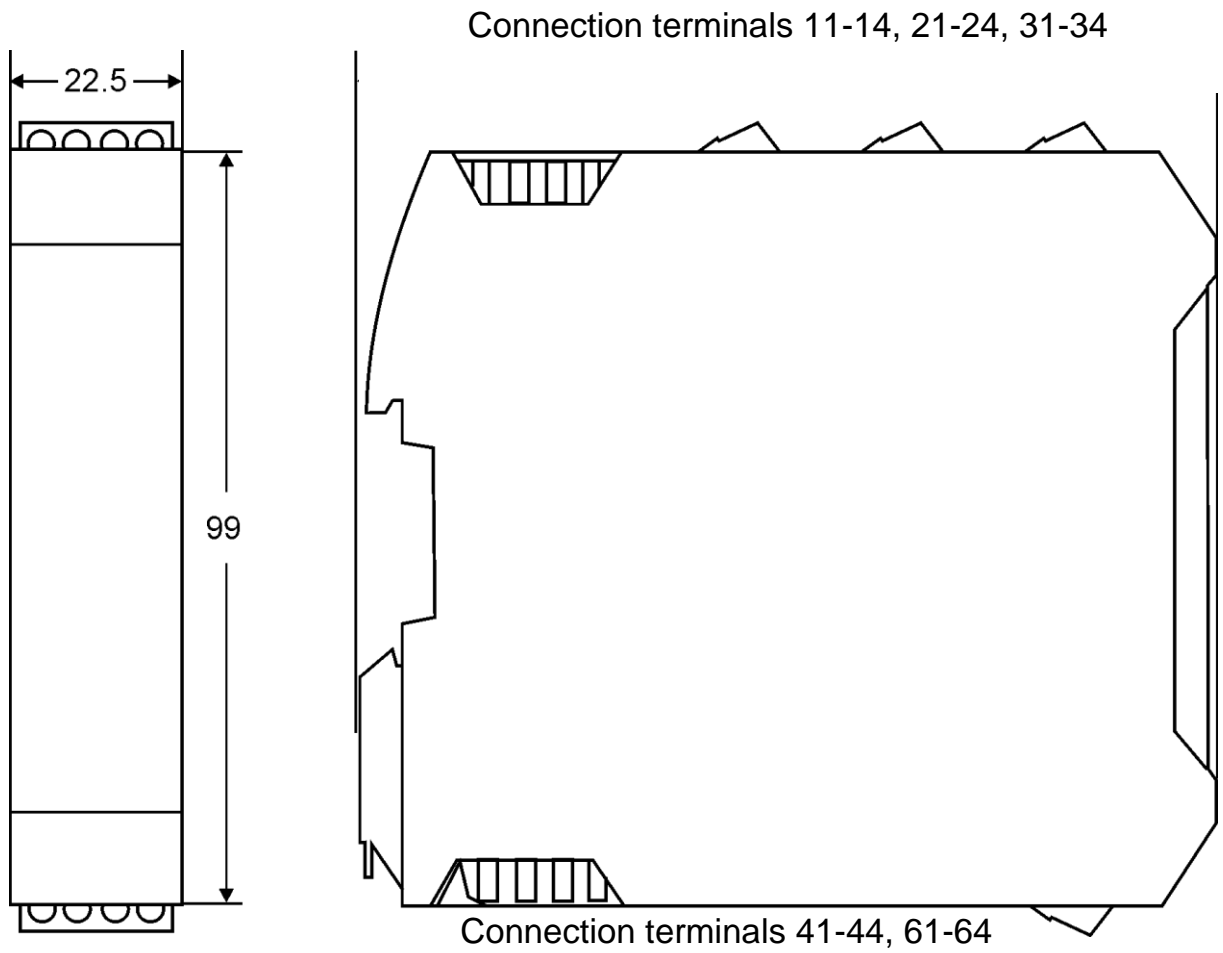

Fig. 35: Dimensions

9 Order code

TB225 - **1.** - **2.** - **3.** - **4.** ..- **5.**

1.	Measurement input	
	0	Universal Input
2.	Switching output	
	0	2 Relays
3.	Auxiliary voltage	
	0	18..230 V AC/DC
4.	Options	
	00	No options
5.	Functional Safety	
		Without SIL-Certification
	SIL	Including SIL-Certification

Table 3

9.1 Accessories

Type	Name
Safety temperature limiter	STL50
Safety thermocouple	TC293, TC296
Safety temperature sensor	TR293, TR296

Table 4

9.2 Troubleshooting

Error	Cause	Remedy
Nothing appears on the display	Auxiliary voltage < 18 V	Check auxiliary voltage at Terminal 11 and 13

Table 5

10 Device transport and storage

Gentle and tension-free packaging of the housing must be ensured for transport (no machine wrapping of the package).

The device must be stored in the environmental conditions specified in the technical data.

11 Returns



The legal regulations for environmental protection and our personnel require that devices which are sent back which have come into contact with liquid are handled without risk to people or the environment.

If you send a device back to us for inspection or repair, we must request that you strictly observe the following requirements:

On the GHM homepage under 'Downloads/forms' a return shipment form can be downloaded.

The repair can be performed quickly and without call-back questions if:

1. a filled-in form is provided for each device,
2. the device has been cleaned and packaging which prevents damage to the device is used, and
3. a safety data sheet for the measuring medium is affixed to the outside of the package, if the device has come into contact with a critical substance.

12 Disposal



Separation by material and recycling of device components and packaging must take place when the device is disposed of. The valid legal regulations and directives applicable at the time must be observed. The device may not be disposed of with household waste. If the device should be disposed of, return it to us with the return shipment form filled in under section 11. We will then arrange for the proper disposal.

13 Imprint

GHM GROUP - Martens

GHM Messtechnik GmbH | Kiebitzhörn 18 | 22885 Barsbüttel

Managing Director:

Dr. Axel Lamprecht

Sitz der Gesellschaft: Tenter Weg 2-8,

42897 Remscheid/ Germany

Wuppertal District Court, Commercial Register Section B 29352

Copyright: GHM Messtechnik GmbH. All rights reserved. Reprints, digital use of any type, and duplication may only take place with the written authorisation of GHM Messtechnik GmbH.

14 EC Certificate of Conformity



EU-KONFORMITÄTSERKLÄRUNG EU-DECLARATION OF CONFORMITY

GHM GROUP - Martens | GHM Messtechnik GmbH | Kiebitzhöh 18 | 22885 Barsbüttel | GERMANY

Dokument-Nr. / Monat.Jahr: **3049 / 01.2022**
 Document-No. / Month.Year:

Wir erklären hiermit als Hersteller in alleiniger Verantwortung, dass die folgenden Produkte konform sind mit den Schutzziele der Richtlinie des Europäischen Parlaments:
 We declare as manufacturer herewith under our sole responsibility that the following products are in compliance with the protection requirements defined in the European Council directives:

Produktbezeichnung: **TB225**
 Product identifier:

Produktbeschreibung: **Temperaturbegrenzer**
 Product description: **Temperature limiter**

Die Produkte entsprechen den folgenden Europäischen Richtlinien:
 The products conforms to following European Directives:

Richtlinien / Directives		Angewandte harmonisierte Normen oder angeführte technische Normen Applied harmonized standards or mentioned technical specifications
2014/30/EU	EMV Richtlinie / EMC Directive	EN 14597:2012 EN 60730-1:2011 EN 60730-2-9:2010
2014/35/EU	Niederspannungsrichtlinie / Low Voltage Directive	EN 60664-1:2007
2011/65/EU	RoHS / RoHS	EN IEC 63000:2018

Diese Erklärung wird verantwortlich für den Hersteller abgegeben durch:
 The manufacturer is responsible for the declaration released by:

Dr. Axel Lamprecht
 Geschäftsführer
 CEO

Barsbüttel, 07. Januar 2022

Diese Erklärung bescheinigt die Übereinstimmung mit den genannten Harmonisierungsrechtsvorschriften, beinhaltet jedoch keine Zusicherung von Eigenschaften.
 This declaration certifies the agreement with the harmonization legislation mentioned, contained however no warranty of characteristics.

15 Notes

Parameter	Werkseinstellung	Benutzereinstellung
1.2 - Unit	°C	
1.3 - Contrast	50%	
1.4 - Language	deutsch	
1.5 - Lighting	auto	
1.6 - Decimal place	without	
2.2 - Signal	PT100	
2.3 - Start analogue input	0 °C	
2.4 - End analogue input	100 °C	
3.2 - Analogue	off	
3.3 - Start analogue output	0 °C	
3.4 - End analogue output	100°C	
3.5 - Analogue output error	> 11V	
3.6 - Alarm - relay	off	
3.7 - Alarm - value	20 °C	
3.8 - Alarm - hysteresis	1 °C	
4.2 - Operating mode	TB max	
4.3 - Threshold	20 °C	
4.4 - Hysteresis	1 °C	
4.5 - External button function	off	
4.6 - Temperature correction	0 °C	
4.7 - Temperature difference	5 °C	

