

Mounting and operating manual

Pressure Transducer

As of Version 2.2

GMUD MP



- ☞ Read carefully before first operation!
- ☞ Consider safety instructions!
- ☞ Keep for future reference!



WEEE-Reg.-Nr. DE 93889386

1	GENERAL NOTE	3
2	SAFETY	3
2.1	INTENDED USE	3
2.2	QUALIFIED STAFF	3
2.3	SAFETY SIGNS AND SYMBOLS	3
2.4	SUITABILITY	3
2.5	REASONABLY FORESEEABLE MISUSE	3
2.6	SAFETY INSTRUCTIONS	4
2.6.1	<i>During configuration</i>	4
2.6.2	<i>During normal operation</i>	4
3	PRODUCT DESCRIPTION	5
3.1	SCOPE OF SUPPLY	5
3.2	OPERATING AND MAINTENANCE	5
3.3	TYPE PLATE	5
3.4	AVAILABLE OPTIONS	5
3.5	GENERAL INSTALLATION INSTRUCTIONS	6
3.5.1	<i>Wall mounting</i>	6
3.5.2	<i>Connector mounting</i>	6
3.5.3	<i>Pressure connection</i>	6
3.5.4	<i>Commissioning</i>	7
3.5.5	<i>Decommissioning</i>	7
3.5.6	<i>Ready for operation</i>	7
3.6	CONNECTION	8
3.7	DISPLAY	9
3.8	KEYPAD	9
4	CONFIGURATION	10
4.1	PASSWORD LOCK	10
4.2	OUTPUT CONFIGURATION	10
4.3	CORRECTION	11
4.4	SEA LEVEL CORRECTION (ONLY FOR ABSOLUTE DEVICES)	11
4.5	TRANSISTOR OUTPUT (ONLY AVAILABLE WITH OPTION –OUT)	11
4.6	FILTER SETTINGS	12
4.7	LOCK SETTINGS	12
5	DETAILS FOR PRESSURE MEASUREMENT	12
5.1	ABSOLUTE PRESSURE	12
5.2	DIFFERENTIAL PRESSURE	12
5.3	RELATIVE PRESSURE	12
6	ERROR AND SYSTEM MESSAGES	13
7	INSPECTION OF ACCURACY / ADJUSTMENT SERVICE	13
8	RESHIPMENT AND DISPOSAL	13
9	SPECIFICATION	14
10	SENSOR ACCURACIES	15
10.1	ACCURACIES WITH STANDARD MEASURING RANGES	15
10.1.1	<i>GMUD-MP special model for low pressure (differential pressure)</i>	15
10.1.2	<i>GMUD-MP standard (differential pressure)</i>	15
10.1.3	<i>GMUD-MP standard (absolute pressure)</i>	15
10.1.4	<i>GMUD-MP special model for barometric pressure</i>	15
10.2	ACCURACIES WITH SPECIFIC MEASURING RANGES	15

1 General note

Any task should exclusively be performed by subject-specific qualified personnel.

The skilled personnel should carefully read and understand the manual before using the device.

Keep this document in reach for reference in case of any doubt.

The liability and warranty of the manufacturer for damages and consequential damages expires with unintended use, failure to observe these operating instructions, non-observance of safety instructions, insufficiently skilled qualified personnel or unauthorized modifications to the device.

2 Safety

2.1 Intended use

The transducers of the GMUD MP series are exclusively suitable for:

Transducing of (depending on device type) differential, relative or absolute pressure (within the pressure range specified on the identification plate meeting all specifications in 9 Specification on page 14 and 10 Sensor accuracies on page 15) into an electrical signal (adjustable, 4..20 mA or 0..10 V). Any other use is not intended!

2.2 Qualified staff

For operating, running, maintaining and commissioning the device, the staff needs to have an adequate level of knowledge of both, the measuring and the meaning of measured values. This manual can be a valuable contribution. All instructions have to be well-understood and complied with. To be sure that there is no risk arising due to misinterpretation of measured values, the operator must have further knowledge in case of doubt - the user is liable for any harm/damage resulting from misinterpretation due to insufficient knowledge. The manufacturer will assume no liability or warranty in case of usage for other purpose than the intended one, ignoring this manual, operating by unqualified staff as well as unauthorized modifications to the device.

2.3 Safety signs and symbols

Warning notices are marked in this manual as shown below:



Caution! This symbol warns of imminent danger, death, serious injuries and significant damage to property at non-observance.



Attention! This symbol warns of possible dangers or dangerous situations which can provoke damage to the device or environment at non-observance.



Note! This symbol point out processes which can indirectly influence operation or provoke unforeseen reactions at non-observance.

2.4 Suitability



The operator is responsible for verifying that the product is suitable for the desired application. In case of doubt please contact our sales and marketing department. The GHM-Messtechnik GmbH is not liable for incorrect choice, mounting, configuration or connection and any result obtained from this!

2.5 Reasonably foreseeable misuse



- This device must not be used at potentially explosive areas!
- The transducer must not be used at a patient for diagnosis or any other medical purpose!
- The differential pressure transducers must not be used as safety pressure monitor for fireplace, exhaust- or ventilating systems!
- Do not use this product as safety or emergency stop device or in any other application where failure of the product could result in personal injury or material damage.

Any failure to comply with these instructions could result in death, serious injury and material damage.

2.6 Safety instructions

This device has been designed and tested in accordance with the safety regulations for electronic devices. However, its trouble-free operation and reliability cannot be guaranteed unless the standard safety measures and special safety advises given in this manual will be adhered to when using the device.

2.6.1 During configuration



When transporting the device from a colder to a warmer ambience condensation may cause a malfunction. In that case, before operating, it is needed to wait until the device temperature has aligned to the ambience.

The conceptual design, particularly when connecting with other devices has to be done thoroughly.



ATTENTION

Internal connections of other devices (e.g. from ground with protective earth) may lead to prohibited voltage levels that could disturb the function, damage or even destruct the device or any connected equipment.

Never run the device with a damaged or faulty power supply.

Risk of death by electrocution!

2.6.2 During normal operation



DANGER

Whenever there may be a risk whatsoever involved in running it, the device has to be switched off immediately and to be marked accordingly to avoid re-starting. Operator safety may be a risk if:

- there is visible damage to the device
- the device is not working as specified
- the device has been stored under unsuitable conditions for a longer time

In case of doubt, please return device to manufacturer for repair or maintenance (with costs).



ATTENTION

After exceeding the specification an inspection or repair at charge at the manufacturer's site is necessary. Tubes, connectors or the sensor element inside the device could be damaged due high pressure or temperature. These damages can (even at a later time) lead to functional disorder.

3 Product description

3.1 Scope of supply

GMUD MP with one elbow-type plug (2 with option /OUT)
Mounting and operating manual GMUD MP
Unit labels (depending on type)

3.2 Operating and maintenance



Treat device and sensor carefully. Use only in accordance with above specification. (Do not throw, hit against etc.). Protect plug and socket from soiling.



ATTENTION

Supply connection / mains operation:
When connecting a mains cable, please take care to connect only allowed components. Carefully check the polarity and the correct connection.

Don't apply overvoltage!



The device contains no serviceable parts inside. In case of errors or malfunction please return device to manufacturer for repair or maintenance (with costs).

3.3 Type plate

Production date code

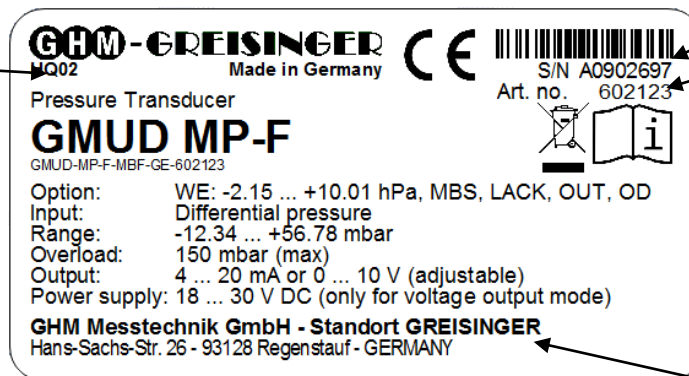

Serial number

Article number

CE-Conformity
(see page 14)

Disposal references
(see page 13)

Carefully read the
manual

Manufacturer address

3.4 Available options

Option	Description
LACK	Printed circuit board coated on both sides (e.g. for outdoor use)
OUT	Additional transistor output
WE: ...	Factory pre-configured (e.g. output configuration)
MBF, MBS	Custom pressure range (see page 15)
OD	Closed housing, display and keypad under top cover



ATTENTION

Option WE: ...
The factory pre-configuration can be changed manually.
Carefully check configuration before every commissioning.



Hint for option -OD:
Open cover for having access to display and buttons

3.5 General installation instructions



All screws and fittings have to be tightened finger tight.



Any cable used must fulfill the correct function of the strain relief. It's only permitted to use cables with sufficient cable cross-section. Cables with visible optical or mechanical damages have to be replaced immediately by faultless ones.



The device operation is only permitted with closed housing, signal- and supply lines being correctly wired, screwed connector sockets with correctly attached connector seal and with pressure lines being correctly connected and secured to prevent accidental releasing.

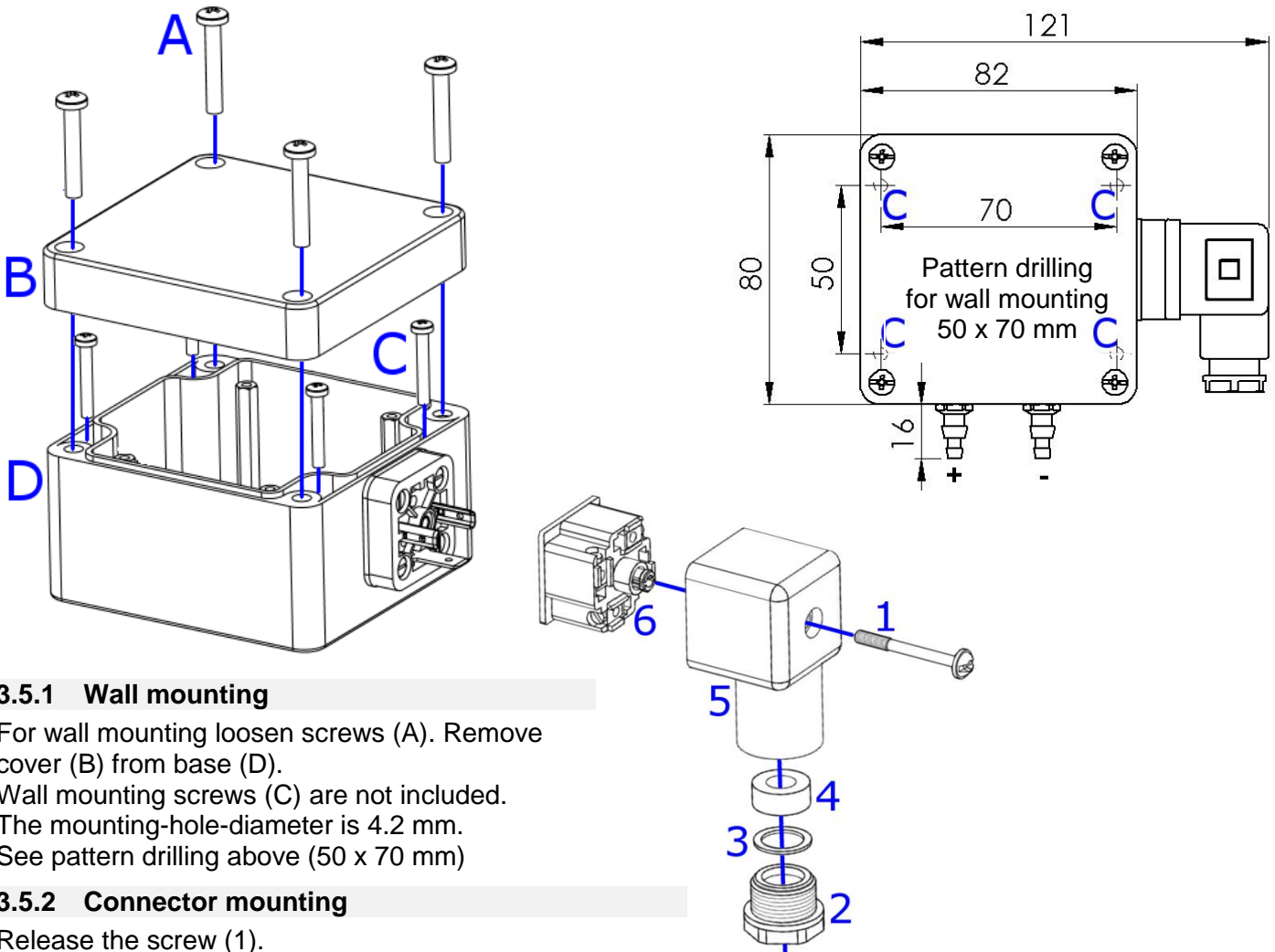

3.5.1 Wall mounting

For wall mounting loosen screws (A). Remove cover (B) from base (D). Wall mounting screws (C) are not included. The mounting-hole-diameter is 4.2 mm. See pattern drilling above (50 x 70 mm)

3.5.2 Connector mounting

Release the screw (1).
 Unplug the connector.
 Release the connection sealing, cable fitting (2), shim (3) and sealing-ring (4).
 Pull out the connection socket (6).
 Thread cable through parts (2), (3), (4) and into connector-housing (5). Connect wires according to wiring diagram on page 8.
 Reattach part (6) in (5). According to mounting situation select best of the 4 possible positions.
 Reattach parts (4) and (3) and tighten (2). Plug in the connector with connection sealing and tighten (1).

3.5.3 Pressure connection

Left pressure port: Higher pressure (+)
 Right pressure port (if available): Lower pressure (-)
 Depending on pressure and pressure-tube a securing for accidental removing is needed (recommendation: GDZ-18 or GDZ-19)

3.5.4 Commissioning

Unpack the device, accessories and check scope of supply (maybe the packing still contains some parts).

Mount the device according to general mounting instructions permanent and safe.

Attach non-active power supply.

Carefully check connection (supply and signal)

Connect transistor output with circuitry or detector (only with option /OUT).

Now activate the power supply.

Configure the device (Settings, output ...).

Check transistor output.

Carefully check normal operation mode of the output ("output in case of an error"):

When exceeding the range, according to configuration the output can change from 20 mA to < 3.6 mA! On a control chain a vent control would keep the vent open! In that case the normal operation mode of the output must be set to > 20 mA to close the vent.

Check correct function of the notification chain (only with option /OUT).

Mount the pressure tubes and secure the tube from accidental removing.

Now apply process pressure.

3.5.5 Decommissioning

Turn off process pressure and wait until the pressure has fallen to 0.

Unplug the pressure tubes after that unplug the supply and all circuitry.

Demount device.

3.5.6 Ready for operation

Right after turning on the device will perform a self-diagnostic check (about 5 sec.)

During this time, all display segments are active and the output is in error-state.

After the check the device will change in measuring mode and is ready for use.

3.6 Connection

Connection for the elbow-type plug (according to device configuration)

Only with option /OUT

Connector left side

DC-isolated switching output,
switching to GND.

Threshold settings via configuration
menu

Connector right side Supply and
signal output Current- or voltage
signal selectable via menu



Switching output

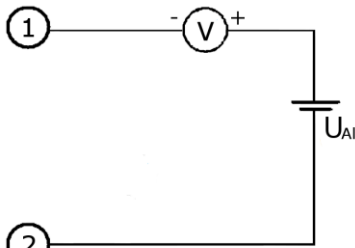

1 = + (U_{AI} max 28V, I_V max 40mA)
2 = -

Current (4..20 mA)

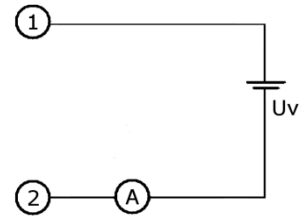

1 = 4..20 mA current loop +
2 = 4..20 mA current loop -
3 = Do not connect!

Voltage (0..10 V)

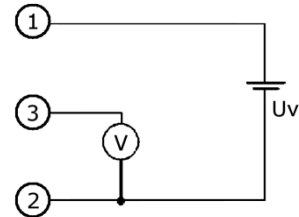

1 = +UV (+18..30 VDC)
2 = GND
3 = 0..10 V output



The cable length on the transistor output must not exceed 3 m and must not leave parts of the building!

An appropriate external surge protection (e.g. in case of direct / indirect lightning stroke) must be installed when using cable length > 30 m, when the cabling is leaving parts of the building or when using on a central direct current feed-in.

Otherwise the following applies:







The cables for 0..10 V and 4..20 mA must not leave parts of the building!
The cables for 0..10 V and 4..20 mA must not exceed a length of 30 m!

3.7 Display

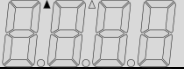
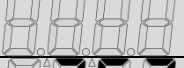

Labels can be replaced in the **transparent unit-window**. To replace a label, unscrew the cover and shove it in.

The displayed unit is according to the configuration set  in



Display	Information
	Correction active Offset-, scale- or sea-level-correction
	Switching output active Upper or lower threshold value
	Value with decimal point according to selected unit.
	Display self test (at device startup)
	Clear (Resets min and max value memory)
	Lo (Displays min value from memory)
	Hi (Displays max value from memory)

3.8 Keypad

Task	Keypad	Display	Description
View min value	Press button ▼ shortly once		For 15 seconds the display will alter between min value and 'Lo'.
View max value	Press button ▲ shortly once		For 15 seconds the display will alter between max value and 'hi'.
View current value	Press button SET shortly once		Current value is displayed
Reset min and max value memory	Press and hold button ▼ and ▲		Resets min and max value memory, display shows 'CLr' (clear) and alters to normal display mode.
Configuration menu	Press and hold button SET		Opens the configuration menu

4 Configuration

Follow these instructions to configure the functions of the device:

- Press button **SET** until the first parameter becomes visible in the.
- Switch to the desired parameter by pressing the button **SET**.
- Use the button **▲** or **▼** to change a value and use button **SET** to validate the value.



If there is no key pressed within the menu mode within 2 minutes, the configuration will be cancelled.

All changed settings will be lost!



Changing the device parameters is password protected by factory default. The password must be set correctly to 185 for entering the menu. The last menu point gives the option to disable the password protection.

4.1 Password lock

Display	Values	Information
SET	Button ▼ and ▲	
	Password	
		For entering the configuration menu the password has to be set to 185.

4.2 Output configuration



To achieve best accuracy the output signal should be at least 50 % of the used sensor's measuring range.

Refer to 10 Sensor accuracies on page 15.

Setting the output to 0..1 mbar when using a sensor range of -10..10 will extremely decrease the accuracy.

Display	Values	Information
SET	Button ▼ and ▲	
	Unit and range of the pressure display <i>The unit defines the decimal point position as well as the display range. Depending on the sensor range some units may not be visible.</i>	
		bar
		mbar
		Pascal
		hecto Pascal
		PSI
	Output type	
		Voltage output (0 ... 10 V)
		Current output (4 ... 20 mA, factory default)
	Output zero point (low value)	
		Display value for an output value of 4 mA (or 0V) (Factory default: <i>Lower measuring range</i>)
	Output scale (high value)	
		Display value for an output value of 20 mA (or 10V) (Factory default: <i>Upper measuring range</i>)
	Output in case of an error	
		Output is <= 3,6 mA / 0V (factory default)
		Output is >= 21 mA / 10,5 V

4.3 Correction

Display	Values	Information
SET	Button ▼ and ▲	
Offset correction of the measuring		
		Not active (factory default)
		Offset correction depending on display unit
Scale correction of the measuring		
		Not active (factory default)
		Scale correction in %
Peak detection of the measuring		
		Not active (factory default)
		Active: Min.- and max.-value from non-averaged measuring value



If higher values are needed, please check sensor, if necessary return to manufacturer for inspection.

Calculation: corrected value = (measured value – OFFS) * (1+ SCAL /100)

4.4 Sea level correction (only for absolute devices)

Display	Values	Information
SET	Button ▼ and ▲	
Sea level correction		
		Not active (factory default)
		Active
Altitude of sea level (only when S.L. on)		
		Altitude deviation to sea level in meters

Calculation formula for the sea level correction







$$p(h_{Alt}) = p_{gemessen} [hPa] \cdot \left(1 - \frac{0,0065 \left[\frac{K}{m} \right] \cdot h_{Alt} [m]}{288,15 [K]} \right)^{5,255} [hPa]$$

Atmospheric conditions: international standard atmosphere

4.5 Transistor output (only available with option –OUT)



Display	Values	Information
SET	Button ▼ and ▲	
Lower alarm value (alarm when below value)		
		Not active (factory default)
		Output is active when measuring is below or equal this value
		Always on
Upper alarm value (alarm when above value)		
		Not active (factory default)
		Output is active when measuring is above or equal this value
		Always on

4.6 Filter settings

Display	Values	Information
SET	Button ▼ and ▲	
	Filter	
		No filtering
		Filtering cycle in seconds (factory default: 0.5 s)
	Fast measuring (only for voltage output and no filtering)	
		Not active (factory default) <i>Averaging over 16 measurements</i>
		Active: fast measuring and measuring output. No averaging.

The filter uses the last calculated value and the average over the set period of time. In 100 ms there will be 16 measurements. The new value will then be calculated as average over the 16 measurements and the last value. When the filter is not active and the fast measuring is active there will be no averaging, each sensor value is displayed and the output will be set to the corresponding signal. This might lead to an output signal and display value that is not smoothly.

4.7 Lock settings

Display	Value	Information
SET	Button ▼ and ▲	
	Lock settings	
		Not active, the password is not checked.
		Active (factory default) To change settings you have to enter the password.

5 Details for pressure measurement

5.1 Absolute pressure

Absolute pressure is the pressure referenced to vacuum (zero pressure).

With no pressure charged (pressure port left open), the atmospheric pressure is measured.

Application field: meteorological measuring (e.g. 1013 hPa abs), vacuum processes.

5.2 Differential pressure

The differential pressure is the difference between 2 pressure levels.

Commonly both pressure levels are charged to one side of the sensor membrane, the sensor then needs two pressure ports.







Application field: HVAC, filter/air filter, velocity pressure.

5.3 Relative pressure

Relative pressure is the differential pressure between a pressure level (over or under pressure) and the atmospheric pressure. For measuring relative pressure with a differential pressure sensor (2 pressure ports) one of the ports has to be left open.

Application field: Pneumatic or hydraulic systems, tire pressure.

6 Error and system messages

Display	Description	Possible fault cause	Remedy
	Above display range	Value >9999	Check settings: Offset and scale. Also check sea level correction on absolute devices
	Below display range	Value < -1999	Check settings: Offset and scale. Also check sea level correction on absolute devices
	System error	Error in device	Disconnect from supply and reconnect. If error remains: return to manufacturer
	Sensor error	Sensor defective	Check sensors, cable and connections for visible damage? Disconnect from supply and reconnect. If error remains: return to manufacturer
	Range or Calculation error	Value missing, not in range or invalid	Keep pressure within measuring range and/or check settings: Unit, offset and scale. Also check sea level correction on absolute devices
	Value is invalid	Restart	Disconnect from supply and reconnect. If error remains: return to manufacturer
	Segment test	The transducer performs a display test for 2 seconds after power up. After that it will change to the display of the measuring.	

7 Inspection of accuracy / adjustment service



The device uses high quality sensor elements. However long-term-drift, pollution and sediments can cause an inaccuracy (e.g. in offset and scale). A periodic (e.g. once a year) routine inspection and adjustment at the manufacturer's site (with costs) is recommended to stay within specified accuracy range.

Calibration certificates - NIST-certificates - other certificates:

When recalibration is necessary the best accuracy can only be achieved by the manufacturer!

The device is using high quality sensors. However long-term-drift, pollution and sediments can cause an inaccuracy (e.g. errors in offset and scale). A periodic routine inspection and adjustment at the manufacturer's site is recommended to stay within specified accuracy range.

8 Reshipment and disposal



All devices returned to the manufacturer have to be free of any residual of measuring media and other hazardous substances. Measuring residuals at housing or sensor may be a risk for persons or environment.



Use an adequate transport package for reshipment, especially for fully functional devices. Please make sure that the device is protected in the package by enough packing materials. Add the completed reshipment form of the GHM website <http://www.ghm-messtechnik.de/downloads/ghm-formulare.html>



The device must not be disposed in the unsorted municipal waste! Send the device directly to us (sufficiently stamped), considering the above if it should be disposed. We will dispose the device appropriately and environmentally sound.

9 Specification

Display range	-1999..+9999 Digit
Accuracy	Model dependent refer to 10 Sensor accuracies on page 15
Pressure media	Suitable for air, non corrosive, non-oxidizing and non-reducing gases
Sensor	Silicon MEMS
Temperature compensation	Integrated in sensor element from 0..70 °C
Measuring rate	Up to 1000 measurements per second
Adjustment	Digital offset and scale correction
Min and max value memory	Memory function for min and max value
Output signals	Arbitrary scale from 0..10 V and 4..20 mA
Scaling	Via selection in settings menu setting the output value for 4 mA (or 0 V) and 20 mA (or 10 V)
Connection	Elbow-type plug according to EN 175301-803 Form A (IP65) Max cable cross-section 1.5 mm ² , cable diameter 4.5..7 mm
Auxiliary energy	4..20 mA: From 4..20 mA current loop 0..10 V: $U_v = 18..30$ V, max 6 mA
Permissible impedance	4..20 mA: $R_A(\text{Ohm}) < ((U_v - 12\text{V}) / 0,02 \text{ A})$ <i>Example: for $U_v = 18\text{V}$: $R_A < (18\text{V} - 12\text{V}) / 0,02\text{A} \Rightarrow R_A < 300 \text{ Ohm}$</i>
Permissible load	0 .. 10 V: $R_L(\text{Ohm}) > 3000 \text{ Ohm}$
Switching output	Max 28 V, 40 mA
Display	4-Digit 7-Segment LCD-Display, display range from -1999..+9999 Digit
Operational controls	3 Switches
Ambient conditions	
Operating / Storage temp.	-20..+70 °C (25 °C nominal temperature) / -40..+70 °C
Relative humidity	0..95 % RH (non-condensing)
Housing	ABS (IP65, without sensor)
Dimension	82 x 80 x 55 mm (without connector and pressure connection)
Mounting	4.2 mm mounting-holes for wall mounting inside the housing
Directives / standards	The device classification according to CiSPR 11 (DIN EN 55011): Class B Group 1, for using in industrial, private and residential areas. The device confirm to following European directives: 2014/30/EU EMC directive 2011/65/EU RoHS 2014/68/EU Pressure equipment directive According to the pressure equipment directive 2014/68/EU for gasses of fluid group 2 the device fulfills the conformity assessment procedure corresponding article 4, paragraph 3. According to this no declaration in the EU conformity is needed. Applied harmonized standards: EN 61326-1 : 2013 EN 61326-2-3 : 2013 Emission level: Class B EMI immunity according to table 1 Additional fault during perturbation: Evaluation criterion A: $\leq \pm 1$ % Evaluation criterion B: $\leq \pm 1,7$ % An appropriate external surge protection (e.g. in case of direct / indirect lightning stroke) must be installed when using cable length > 30 m, when the cabling is leaving parts of the building or when using on a central direct current power supply. The cable length on the transistor output must not exceed 3 m and must not leave parts of the building!

10 Sensor accuracies

10.1 Accuracies with standard measuring ranges

Percent specification relating to whole measuring range at nominal temperature range (0..+70 °C)

Lin: typical accuracy deviation due linearity effects (offset and scale)

T+H: typical accuracy deviation due temperature and hysteresis effects

Max.: maximum accuracy deviation

10.1.1 GMUD-MP special model for low pressure (differential pressure)

Order code	Measuring range	Overload pressure	Burst pressure	Accuracy*		
				Lin,	T+H,	(Max.)
GMUD-MP-F-MR0	0.000..1.000 mbar	250 mbar	500 mbar	± 0.35 %	± 1.5 %	(± 6.0 %)
GMUD-MP-F-MR1	0.00..10.00 mbar	150 mbar	200 mbar	± 0.15 %	± 0.6 %	(± 1.5 %)
GMUD-MP-F-MR2	0.00..20.00 mbar	150 mbar	200 mbar	± 0.15 %	± 0.6 %	(± 1.5 %)
GMUD-MP-F-MR3	-1.999..+2.500 mbar	250 mbar	500 mbar	± 0.15 %	± 0.9 %	(± 1.0 %)
GMUD-MP-F-MBF:- 10.00..+10.00diff	-10.00...+10.00 mbar	150 mbar	200 mbar	± 0.15 %	± 0.6 %	(± 0.9 %)
GMUD-MP-F-MR4	-19.99..+20.00 mbar	150 mbar	200 mbar	± 0.15 %	± 0.6 %	(± 0.9 %)

10.1.2 GMUD-MP standard (differential pressure)

Order code	Measuring range	Overload pressure	Burst pressure	Accuracy*		
				Lin,	T+H,	(Max.)
GMUD-MP-S-MR0	0.0..100.0 mbar	1000 mbar	1500 mbar	± 0.15 %	± 0.6 %	(± 1.5 %)
GMUD-MP-S-MR1	0.0..500.0 mbar	1000 mbar	1500 mbar	± 0.15 %	± 0.6 %	(± 1.5 %)
GMUD-MP-S-MR2	0..1000 mbar	2000 mbar	3000 mbar	± 0.15 %	± 0.6 %	(± 1.5 %)
GMUD-MP-S-MR3	0..2000 mbar	4000 mbar	6000 mbar	± 0.15 %	± 0.6 %	(± 1.0 %)
GMUD-MP-S-MR4	0..5000 mbar	7000 mbar	7000 mbar	± 0.15 %	± 0.6 %	(± 1.0 %)
GMUD-MP-S-MBS:- 50.0..+50.0diff	-50.0...+50.0 mbar	150 mbar	200 mbar	± 0.15 %	± 0.6 %	(± 0.9 %)
GMUD-MP-S-MR5	-100.0..+100.0 mbar	1000 mbar	1500 mbar	± 0.15 %	± 0.6 %	(± 0.9 %)
GMUD-MP-S-MR6	-500..+500 mbar	1000 mbar	1500 mbar	± 0.15 %	± 0.6 %	(± 0.9 %)
GMUD-MP-S-MR7	-1000..+1000 mbar	2000 mbar	3000 mbar	± 0.15 %	± 0.6 %	(± 0.9 %)

10.1.3 GMUD-MP standard (absolute pressure)

Order code	Measuring range	Overload pressure	Burst pressure	Accuracy*		
				Lin,	T+H,	(Max.)
GMUD-MP-S-MA0	0..1100 mbar	4000 mbar	6000 mbar	± 0.2 %	± 1.0 %	(± 3.0 %)
GMUD-MP-S-MA1	0..2000 mbar	4000 mbar	6000 mbar	± 0.15 %	± 0.6 %	(± 1.5 %)
GMUD-MP-S- MBS:0..5000abs	0..5000 mbar	7000 mbar	7000 mbar	± 0.15 %	± 0.6 %	(± 1.5 %)

10.1.4 GMUD-MP special model for barometric pressure

Order code	Measuring range	Overload pressure	Burst pressure	Accuracy*		
				Lin,	T+H,	(Max.)
GMUD-MP-S- MBS:+600..+1100abs	600..1100 mbar	2000 mbar	3000 mbar	± 0.15 %	± 0.6 %	(± 1.3 %)

10.2 Accuracies with specific measuring ranges

Can be ordered by using option -MBS or -MBF.

From the respective range limits any range can be selected.

The accuracy of the sensor specifies the system accuracy. The ranges highlighted in the table above show the highest possible accuracy.

The minimum display value is -1999 because of the 7-segment display. A +- 500.0 mbar sensor can be ordered as -199.9..500.0 mbar or -500..500 mbar.

With intermediate ranges the accuracy will change. The expected accuracy can be calculated as follows:

Sensor range / measuring range * accuracy

e.g. desired range -10..+600 mbar -> measuring range e: 10 + 600 = 610

Next sensor -1000..+1000 mbar -> sensor range: 1000 + 1000 = 2000, accuracy = 0.9%

Accuracy GMUD MP-S-10..+600 = 2000 / 610 * 0.9 % = 2.95 %

* Accuracy without possible EMC effects, refer to 9 Specification on page 14.

