

Conductivity-Panelmeter LF 9648

Conductivity measurement with 2-and 4-electrode cells

Features

- LED-Display 14.2 mm red
- Indicating range 2000(0) Digit
- Measuring ranges programmable from 0 ... 2.000 $\mu\text{S}/\text{cm}$ up to 0 ... 2000 mS/cm
- Temperature compensation with RTD, Pt100 or Pt1000 Sensor
- Monitoring of ultra-pure water (pharmacoica) acc. to USP<645>
- Max. 4 alarm outputs, relay SPDT or transistor
- Isolated analog output 0/4 ... 20 mA and 0/2 ... 10 V DC or 2 isolated passive analog outputs 4 ... 20 mA
- Front Protection IP65



DIN 96x48 mm

General

The Conductivity-Panelmeter LF9648 has been designed for the measurement of conductivity, as a degree of the purity or concentration of a liquid. In connection with 4-electrode-conductivity-cells a high accuracy, and insensitivity of contaminations can be achieved. A further advantage is a broad range of application with only one cell. Only for measurements in ultra-pure water a special 2-electrode-conductivity-cell must be used. We offer a broad line of conductivity cells. Please contact us for more information.

Short information

Programming	Parameters are programmed via front-side membrane keypad.
Alarm outputs	Switching performance of the alarm outputs is programmable as minimum or maximum function.
USP-alarm	Devices including option 14 are programmable for monitoring of ultra-pure water acc. to USP<645>. Setpoint settings of the alarm outputs are in accordance to the conductivity-temperature table (page 11). The switching performance is programmable for NC or NO contact.
Analog output active	Proportional to the input signal an isolated analog output signal 0 ... 20 mA/0 ... 10 V DC or 4 ... 20 mA/2 ... 10 V DC can be generated. Output changes automatically from current signal to voltage signal depending on burden.
Analog output passive	Proportional to the conductivity and temperature an isolated output signal 4 ... 20 mA will be generated.
USP calibration	Devices including option 14 have a special routine for USP calibration. Test-equipments in accordance to NIST are e.g. calibration solution EC23.8 and a precision thermometer type N63802.

Technical data

Power supply

Supply voltage	: 230 V AC $\pm 10\%$; 115 V AC $\pm 10\%$, 24 V AC $\pm 10\%$ or 24 V DC $\pm 15\%$
Power consumption	: max. 3.5 VA, with analog output 5 VA
Operating temperature	: -10 ... +55 °C
Rated voltage	: 250 V ~ acc. VDE 0110 between input/output/supply voltage Degree of pollution 2, over-voltage category III
Test voltage	: 4 kV=, between input/output/supply voltage
- conformity	: EN55022, EN60555, IEC61000-4-3/4/5/11/13

Inputs

Conductivity input	: 0 ... 2.000(0) $\mu\text{S}/\text{cm}$ to 0 ... 2000 / 200(0) mS/cm (at 25 °C)
-Cell constant	: 0.080 ... 9.999
-Accuracy	: 0.5 % of the measuring range, ± 2 Digit
-Temperature comp.	: non linear for pure and natural water or linear adjustable from 0.000 ... 9.999 %/K
-Temperature coefficient	: 0.02 %/K
Temperature input	: -50.0 ... 200.0 °C; RTD Sensor Pt100 or Pt1000
-Accuracy	: ± 0.2 °C
-Linearize error	: ± 0.1 %

Display

Display range	: LED red, 14.2 mm
Parameter display	: 2000(0) digit with leading zero suppression LED 2-digit red, 7 mm (Parameter - and output indicator)

Outputs

Relay	: SPDT < 250 V AC < 250 VA < 2 A, < 300 V DC < 50 W < 2 A
Transistor	: max. 35 V AC/DC/100 mA, short circuit protected
Analog output active	: 0/4 ... 20 mA burden $\leq 500 \Omega$; 0/2 ... 10 V burden $> 500 \Omega$, isolated Automatic output changing (burden dependent)
Analog outputs passive	: 4...20 mA, ext. burden = $RA[\Omega] \leq (\text{supply voltage} - 5 \text{ V}) / 0.02 \text{ A}$; Supply voltage 5 ... 30 V DC, supply error 0.005 %/V
-Accuracy	: 0.1 %; TK 0.01 %/K

Panel case

Dimensions	: DIN 96x48 mm, material PA6-GF; UL94V-0
Weight	: Front 96x48 mm, mounting depth 100 mm
Electrical connection	: max. 390 g
Protection	: Clamp terminals, 2 mm ² single wire, 1,5 mm ² flexible wire, AWG14 Front IP65, terminals IP20, fingersafe acc. German BGV A3

Dimensions

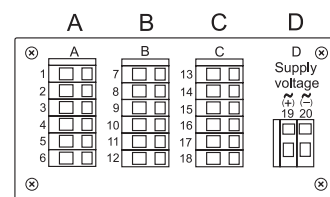
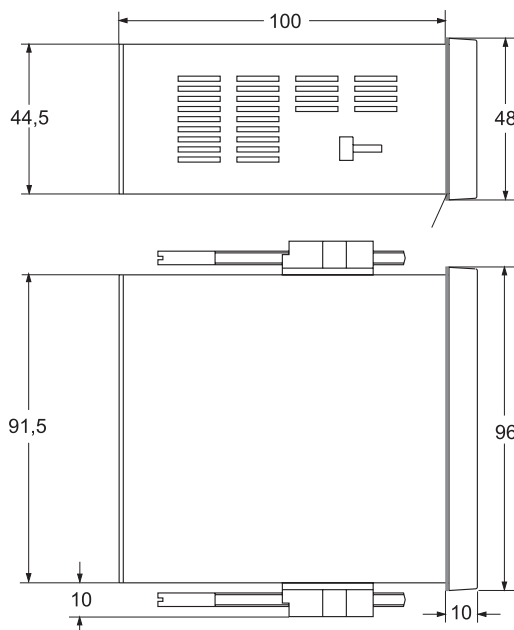

Position terminal strips

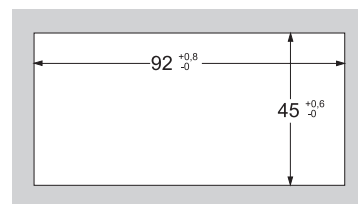

Panel cut-out acc. to
DIN 43700-96x48

Connection diagrams

Terminal strip A

Input conductivity-cell (connection diagrams for cells see separate data sheet)

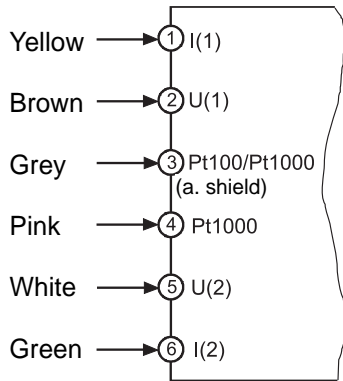

Cable colours only with martens converted connection cables

Terminal strip B (varies with version)

2 alarm outputs

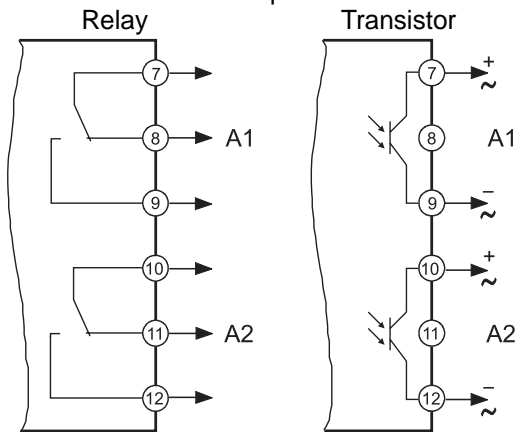

Terminal strip C (varies with version)

2 alarm outputs

Analogue output active

Analogue output passive

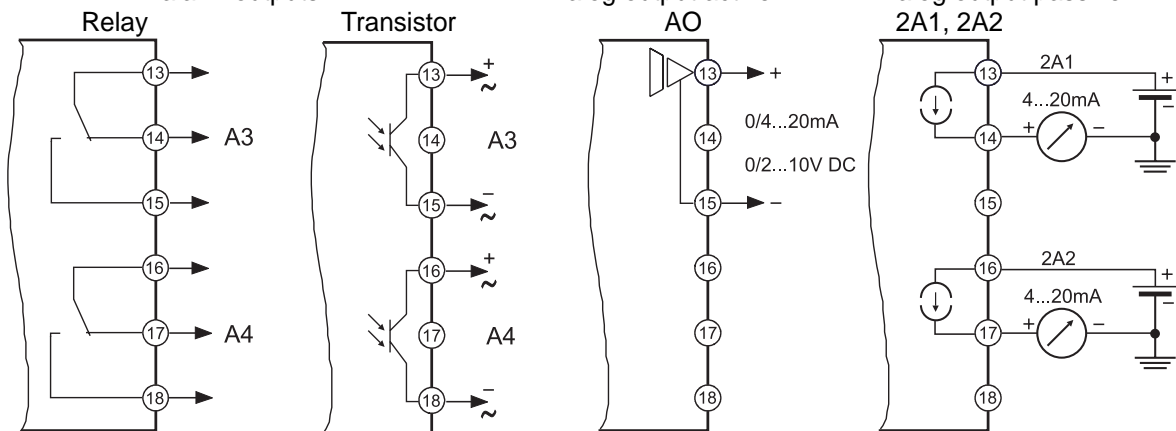

Terminal strip D supply voltage (varies with version)

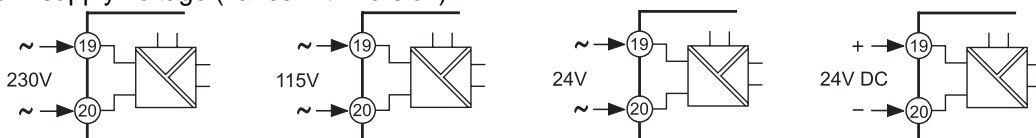

Controls and indicators

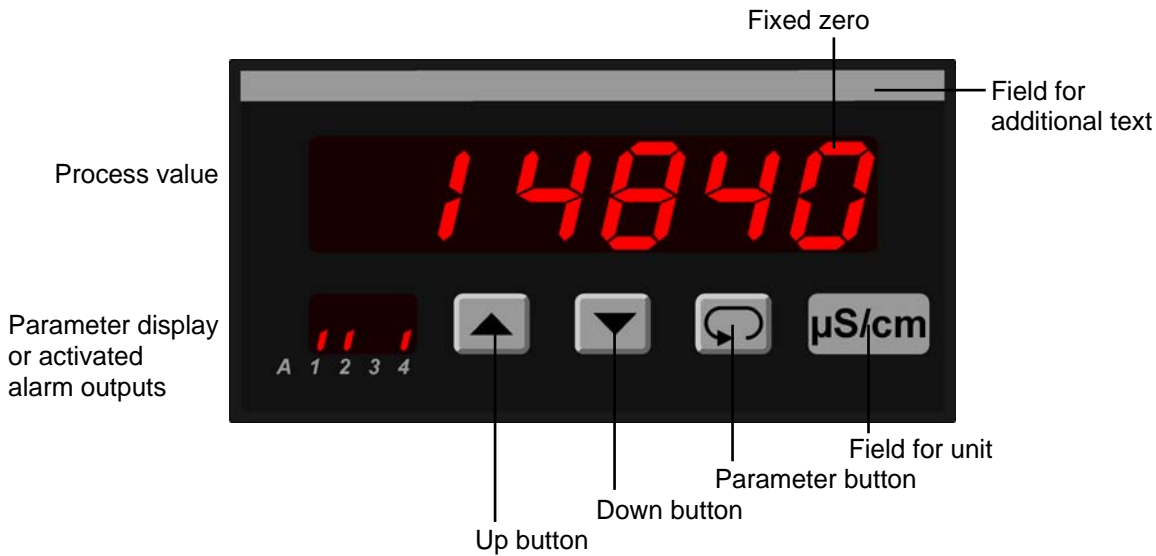

Description

Operation of the device is arranged in 2 levels. The requested parameter can be called by the button . For selection within a parameter or entering data, use the buttons and .

Button combinations:

- + one parameter back.
- + setting parameter to zero or minimum value.

After power-on, the device initialize itself. The display shows the message *init*. After the initializing procedure the device is located in the **Working level**. Temperature and peak memory can be called back, set points of the alarm outputs can be programmed.

Before the device can be used, it must be configured for the intended use.

Pressing the button for more than 2 seconds, activates the **Configuration level**. Now all parameters, which defines the function of the device, can be programmed. E.g. the measuring input, switching performance of alarm outputs and the analog output signal.

After finishing the configuration or when no button was pushed for more than 2 minutes, the program returns to the working level. Leaving the configuration level is possible at any time by pressing the button for 2 seconds.

Error codes:

Display flashes If the measured signal is more than 3 % out of the programmed range the A/D- converter is over driven and the display flashes with appr. 1 Hz

Error! EEPROM test. Reading this message, a program error has been occurred. When pushing the button a copy of the EEPROM will be reloaded and the device works with factory settings. If this copy does not work, please ship the panelmeter to factory for repair service.

Loc Programming lock active. See page 8.

RRnBE The calibration could not be finished during the USP-calibration because the conductivity is too high.

Notes to representation



Parameter is only displayed when configured













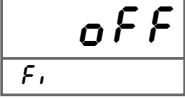



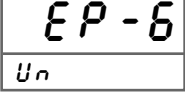



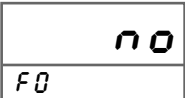



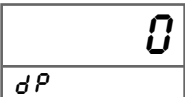



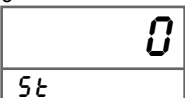

Parameter is only displayed when feature is included (see order code)

Please Note: All parameters can be called if they are not blocked by other programmed parameters and if they are available. **Factory settings** are shown in the display.

Working level

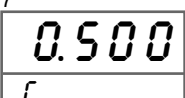
Button	Display	Description
↓	1823	Process value Output indication (only if installed and activated)
↺		
↓	1500 PP	Display peak reading (option 01). Maximum value. Reset with buttons ▼ or ▲, or at every power off.
↺		
↓	15 nP	Display peak reading (option 01). Minimal value. Reset with buttons ▲ or ▼, or at every power off.
↺		
↓	25.30C t	Process temperature [°C].
↺		
↓	noCAL. CR	Calibration acc. to USP<645>. noCAL. or CAL. This Parameter only appears for devices with option 14. Parameter for USP<645> calibration, see page 9. Selection with buttons ▲ and ▼.
↺		
		⚠ After selection of CAL calibration USP<645>, the previous parameter values are deleted.
↓	125 A1	Setpoint output A1. Setting possible from St (start value) ... En (end value) , or 50... 100 % (for USP-contact) with buttons ▲ and ▼.
↺		
		Note: Setpoints for alarm outputs A1 ... A4 have to be configured in the same way.

Configuration

Button	Display	Description (Display graphic shows factory settings)
 Press 2 s	¹  <i>OFF</i> <i>F_n</i>	Digital filter <i>OFF</i> , <i>ON</i> averaging of the last 16 measured values. Selection with buttons  and  .
	²  <i>EP-6</i> <i>U_n</i>	Unit <i>EP-6</i> → μS/cm <i>EP-3</i> → mS/cm Selection with buttons  and  .
	³  <i>n0</i> <i>F0</i>	Fixed zero 0, e.g. 2000 + 0 <i>n0</i> ; <i>YES</i> Selection with buttons  and  .
	⁴  <i>dP</i>	Decimal point position if <i>F0</i> = <i>n0</i> 0. 0 .00 .000 if <i>F0</i> = <i>YES</i> 0. .00 .000 .0000 Selection with buttons  and  .
	⁵  <i>St</i>	Start value for indicating range and analog output AO or 2A1 Setting possible from 0 ... <i>En</i> with buttons  and  . In case of modification a new configuration of the alarm outputs is necessary.
	⁶  <i>En</i>	End value for indicating range and analog output AO or 2A1 Setting possible from <i>St</i> ... 2000 with buttons  and  . In case of modification a new configuration of the alarm outputs is necessary.
	⁷  <i>ε</i>	Cell constant C of the used cell. Settings possible from 0.000 ... 9.999 with buttons  and  .
		

Continue
page 7

Button	Display	Description (Display graphic shows factory settings)															
↓	<div style="border: 1px solid black; padding: 2px;"> ⁸ 4-Pol. Ct </div>	Cell type/measurement system <i>2-Pol.</i> or <i>4-Pol.</i> measurement. Selection with buttons ▲ and ▼.															
↺																	
↓	<div style="border: 1px solid black; padding: 2px;"> ⁹ H2O Ct </div>	Temperature compensation mode. <i>H2O</i> , setting for all natural waters to consider the characteristic of pure water acc. to ASTM D1125-95 and non linear curve acc. to DIN EN27888. <i>Lin</i> , Setting for salted solutions, acid, thindowned or lye and suds. Selection with buttons ▲ and ▼.															
↺																	
↓	<div style="border: 1px solid black; padding: 2px;"> ¹⁰ 2.160 Ct. </div>	Temperature coefficient [%/K] Measuring value correction with diverging to 25 °C. Setting possible from 0 0 0 0 ... 9 9 9 9 with buttons ▲ and ▼.															
↺																	
↓	<div style="border: 1px solid black; padding: 2px;"> ¹¹ 0 Sc </div>	Sensor correction Setting possible from -9.9 ... 9.9 °C with buttons ▲ and ▼.															
↺																	
		<table border="1"> <thead> <tr> <th>Cable length</th> <th>Pt100</th> <th>Pt1000</th> </tr> </thead> <tbody> <tr> <td>2 m</td> <td>-0.7 °C</td> <td>-0.1 °C</td> </tr> <tr> <td>5 m</td> <td>-1.8 °C</td> <td>-0.2 °C</td> </tr> <tr> <td>10 m</td> <td>-3.6 °C</td> <td>-0.4 °C</td> </tr> <tr> <td>25 m</td> <td>- 8.9 °C</td> <td>-0.9 °C</td> </tr> </tbody> </table>	Cable length	Pt100	Pt1000	2 m	-0.7 °C	-0.1 °C	5 m	-1.8 °C	-0.2 °C	10 m	-3.6 °C	-0.4 °C	25 m	- 8.9 °C	-0.9 °C
Cable length	Pt100	Pt1000															
2 m	-0.7 °C	-0.1 °C															
5 m	-1.8 °C	-0.2 °C															
10 m	-3.6 °C	-0.4 °C															
25 m	- 8.9 °C	-0.9 °C															
↓	<div style="border: 1px solid black; padding: 2px;"> ¹² off Al </div>	Switching performance output A1 Function <i>off</i> ; <i>onL</i> (min), <i>onJ</i> (max), <i>USP⁺</i> (NC) oder <i>USP⁻</i> (NO) If activated, the setpoint will be set to the start value. Selection with buttons ▲ and ▼. If <i>USP</i> is selected, the alarm contact switches at the setpoint of the allocated alarm output, according to the limit value table USP<645> page 9. The alarm contact opens or closes if the limit value ist reached. If the process value decra- ses the setpoint with the hysteresis of 0.10 µS/cm*, the contact switches back again. *see page 8.															
↺																	
↓	<div style="border: 1px dashed black; padding: 2px;"> ¹³ 0 Al </div>	Setpoint output A1 Setting possible from 5t (start value) ... En (end value) or 50 ... 100 % according to the USP-table, with buttons ▲ and ▼. Display characters at USP-contact: <i>Al USP X = 100 0%</i>															
↺																	

Continue
page 8

Button	Display	Description (Display graphic shows factory settings)
		(This parameter is disabled at selection of parameter 12 <i>U S P X</i> , Hysteresis fixed on 0.10 μ S/cm)
↓		14 Hysteresis A1 Setting possible from 1 ... 9 9 9 9 (0) Digit with button ▲ and ▼.
↻		Note: The parameter settings for A2 have to be configured the same way.
↓		15 Selection of the active analog output AO conductivity 0 - 20 mA (0 - 10 V DC) or 4 - 20 mA (2 - 10 V DC). Changing from current to voltage output depended on burden ($\leq 500 \Omega$ = current output, $> 500 \Omega$ = voltage output). Selection with buttons ▲ and ▼.
↻		Note: passive output 2A1 (conductivity) only 4 ... 20 mA (see connection diagram page 3).
↓		16 Passive analog output for temperature 2A2, start value Setting possible from - 5 0 . 0 ... 2 0 0 . 0 °C with buttons ▲ and ▼.
↻		
↓		17 Passive analog output for temperature 2A2, end value Setting possible from - 5 0 . 0 ... 2 0 0 . 0 °C with buttons ▲ and ▼. If $t5 > tE$, the analog output is operating with a decreasing curve.
↻		Note: Start and end value of the passive analog output 2A1 are defined with measuring range conductivity.
↓		18 Code for factory settings
↻		
↓		19 Programming lock oFF : no lock Lo n F. : configuration level locked ALL : all parameters locked Selection with buttons ▲ and ▼.
↻		
		Return to the working level

USP <645> Calibration (Option 14)

Following parameters are displayed if USP<645> calibration is selected. Operating with the following parameter makes it sure, that the whole measuring system is calibrated.

-  After selection of parameter for USP<645> calibration (page 5), the previous parameter values are deleted. During the calibration procedure, the analog outputs for conductivity, temperature and alarm outputs are fixed to their current values.



24.50°C
t E

Temperature measurement

Immerse the ultra-pure water cell into the calibration solution (e.g. EC 23.8). Determine the temperature with a thermometer (e.g. N63802). The cell and the thermometer must be immersed at least 6 cm. Wait until the measured temperature does not change.



The determined temperature can be set with buttons  or .

This parameter will not be left automatically after 120s.





23.57
c c

Conductivity calibration

The conductivity of the calibration solution will be determined in accordance to the measured temperature (see label on the bottle of the calibration solution). Exceeds the measured value 70 $\mu\text{S}/\text{cm}$ the calibration is not possible. The display shows the message " r R n S E " .



The determined conductivity can be set with the buttons  or .

This parameter is not be left automatically after 120s.

End of USP <645> calibration

Back to the process value

Measurement of the conductivity of ultra-pure water acc. to USP<645>

Special requirements are demanded in the pharmaceutical industry to the used ultra-pure water. The U.S. Pharmacopeia defines the limit values for conductivity in the chapter <645> for monitoring devices. These directives are acknowledged in the EU, too.

This supervising is subdivided in 3 stages. Stage 2 and stage 3 are external tests and stage 1 is an inline test and specified for low cost and permanent monitoring of the ultra-pure water quality.

USP<645> stage 1

According to stage 1 only the conductivity and temperature has to be measured without temperature compensation. The limit value of the conductivity is defined in the temperature-conductivity table. For all the 5 °C steps of the temperature one limit value is valid.

Limit table for conductivity of ultra-pure water acc. to USP<645> stage 1

Temperature [°C]	Conductivity [$\mu\text{S}/\text{cm}$]	Temperature [°C]	Conductivity [$\mu\text{S}/\text{cm}$]
0.0 ... 4.9	0.6	55.0 ... 59.9	2.1
5.0 ... 9.9	0.8	60.0 ... 64.9	2.2
10.0 ... 14.9	0.9	65.0 ... 69.9	2.4
15.0 ... 19.9	1.0	70.0 ... 74.9	2.5
20.0 ... 24.9	1.1	75.0 ... 79.9	2.7
25.0 ... 29.9	1.3	80.0 ... 84.9	2.7
30.0 ... 34.9	1.4	85.0 ... 89.9	2.7
35.0 ... 39.9	1.5	90.0 ... 94.9	2.7
40.0 ... 44.9	1.7	95.0 ... 99.9	2.9
45.0 ... 49.9	1.8	≥ 100	3.1
50.0 ... 54.9	1.9		

Requirements to a conductivity measuring system acc. to USP<645>

A conductivity measuring system must fulfill the following requirements:

Calibration

Conductive-measuring device

Accuracy	±0.1 µS/cm (@ 1.3 µS/cm)
Resolution	±0.1 µS/cm
Temperature measurement	±1 °C
Temperature compensation	without
Dynamic range	10 ²
Setpoint	1.3 µS/cm @ 25 °C ±0.1 µS/cm
Hysteresis	0.1 µS/cm

Conductive-cell

Cell-constant	Accuracy ±2 %
Temperature sensor	not intended
Surface roughness of the electrodes	< 0.8 µm EHEDG-Recommendation (European Hygienic Engineering & Design Group, brussel)

All equipments and conductivity cells from Martens Elektronik for measuring of ultra-pure water fulfills these requirements. For the realization of an pre-alarm the setpoints for Alarm AL1 ... AL4 are programmable in the range 50 ... 100 % of the allowable limit value (acc. to table stage 1).

Parameter settings for USP<645>

For the right switching performance of the alarm contact, it is necessary to configure the wanted alarm output. Following parameter settings are necessary:

Parameter U_n	Unit	: EP - 5
Parameter F_0	Fixed zero	: 00
Parameter d_P	Decimal point position	: 00
Parameter S_t	Start value	: 0.00
Parameter E_n	End value	: 20.0
Parameter ζ	Cell constant	: label at cell
Parameter ζ_t	Cell type / measurement system	: 2 - P o L
Parameter t_c	Selection temp compensation	: Lin
Parameter t_c	Temperature coefficient	: 0.000

Calibration of conductive measuring systems acc to USP<645>

Conductivity systems for ultra-pure water monitoring must be calibrated in regular time intervals. In accordance to USP<645> a calibration has to be traceable according. to NIST (National Institute of Standards and Technology U.S.) -measuring device- or according. ASTM (American Society for Testing and Materials) -conductivity cell- .

All delivered measuring equipments for ultra-pure water measurement of Martens Elektronik are factory calibrated with precision resistance (treaceable to NIST). The cell constant was found out with calibration solution (traceable to ASTM) and printed on the label. This way of calibration is in accordance with the recommendation of USP<645>.

Field calibration

For the calibration in the field the method how it is carried out before the delivery is not practicable. The calibration of the complete system is simpler and safer. Martens Elektronik recommends the calibrating solution EC23.8 and the precision thermometer N63802 for the calibration.

If other calibrating solutions should be used, it is to consider that at pure-water measuring cells can come to a polarization effect at the electrodes if the calibrating solution has a conductivity of more than 50 µS/cm. This leads to an additional measuring error and the demanded precision can not be adhered to by 2 % for certain. So such solutions should not to be used. Devices including option 14 have a special routine for USP calibration for the whole measuring-system. During the calibration procedure the analog outputs for conductivity, temperature and the alarm outputs are fixed to their current values. To be able to extend the measuring cell for the calibration, a lockable bypass must be installed.

Importantly information of the calibration solution EC23.8.

The calibration solution has a conductivity of 23.8 $\mu\text{S}/\text{cm}$ at 25 °C and is traceable to the standard of the ASTM D-1125 Method A. Each bottle has a label with the temperature-conductivity table and the expiry date. Ideal storage conditions for a storage time of 12 month are a dark room and ambient temperature. For the calibration it is possible to use clean and big vessels. The minimum immersing depth must be at least 60 mm. Used solutions have to be wasted after the calibration (danger of soiling).

Temperature-conductivity-table calibration solution EC23.8

Temperature [°C]	Conductivity [$\mu\text{S}/\text{cm}$]
15	19.17
16	19.64
17	20.10
18	20.56
19	21.03
20	21.49



Temperature [°C]	Conductivity [$\mu\text{S}/\text{cm}$]
21	21.94
22	22.41
23	22.87
24	23.34
25	23.80
30	26.12

Temperature compensation

For accurate conductivity measurement a well matched temperature compensation is needed. The LF9648 offers two modes of temperature compensation:

Water Use this setting for "natural water" like ground water, spring water, above ground water and ultra-pure water. The temperature compensation will be calculated by considering the measured temperature and conductivity. The method of calculation is based on the "non-linear characteristic of natural water" according EN27888 and the electrical conductivity of ultra-pure water according ASTM D11245-95 (ASTM=American Society of Testing and Materials). In the temperature range from 0 °C to 100 °C good results are effected.

Linear Use this setting for saline solution, dilute acid, caustic solution and cleansing solution. This solution will be compensated by using a "linear characteristic". By factory setting the temperature coefficient is set to compensate a NaCl solution. Other solutions needs a special TC. Use the data sheet of the suppliers to define the TC. If there is no information about the TC available, use following procedure:

- ① Dip the conductivity cell into the solution
- ② Stir the solution constantly and heat it to a temperature of 25 °C (watch temperature on the display)
- ③ Notice the measured conductivity at 25 °C
- ④ Heat the solution to the working temperature (minimum difference 10 °C)
- ⑤ Use button  to select "t.C." parameter .
- ⑥ Use the buttons  and  to change the parameter until the displayed conductivity is the same as shown at 25 °C

If there is no way to use this procedure, following values can be used approximately:

NaCl-solution	(20 % weight of electrolyte)	2.160 %/°C (factory setting)
NaOH-solution	(20 % weight of electrolyte)	2.990 %/°C
KOH-solution	(20 % weight of electrolyte)	1.980 %/°C
H ₃ PO ₄ -solution	(20 % weight of electrolyte)	1.140 %/°C
H ₂ SO ₄ -solution	(20 % weight of electrolyte)	1.450 %/°C
NH ₄ NO ₃ -solution	(20 % weight of electrolyte)	1.790 %/°C

Ordering code

LF9648 - 1. - 2. - 3. - 4. - 5. - 6. - 7.

1. Terminal strip A

- 1 Input 2- or 4- electrode-cell,
temperature compensation with Pt100 sensor
- 3 as 1, but temperature compensation with Pt1000 sensor

2. Terminal strip B

- 00 not installed
- 2R 2 alarm outputs relay
- 2T 2 alarm outputs transistor

3. Terminal strip C

- 00 not installed
- 2R 2 alarm outputs relay
- 2T 2 alarm outputs transistor
- AO Analog output active
0/4 ... 20 mA and 0/2 ... 10 V DC, isolated
- 2A 2 analog outputs passive,
4 ... 20 mA for conductivity and temperature, isolated

4. Terminal strip D supply voltage

- 0 230 V AC ± 10 % 50-60 Hz
- 1 115 V AC ± 10 % 50-60 Hz
- 4 24 V AC ± 10 % 50-60 Hz
- 5 24 V DC ± 15 %

5. Option

- 00 without option
- 01 min- and max-peak hold
- 14 measuring and monitoring of ultra-pure water acc. to **USP<645>** (USP623)

6. Unit (appears in the unit field)

7. Additional text (will be placed in the field for additional text max. 3 x 90 mm, HxW)

Custom configuration on request!